



2025 *West Point*  WOODWORKING



## **FABRIC & LEATHER BENCHES**

---

- Available on most solid top benches
- See page 32

## **LARGE EXTENSION TABLES**

---

- Extra leaf options
- Available on most trestle, leg, and double pedestal tables
- See page 33

## **LIVE EDGE PROGRAM**

---

- Pick your own base
- Simplified pricing
- More top size options
- See pages 178-187





# TABLE OF CONTENTS

New & Discontinued Products.....	6-7	Excellent Sellers .....	23
Single Pedestal Tables.....	8	Ordering Information.....	24
Double Pedestal Tables.....	9	Warranty .....	24
Leg Tables .....	10	Attention To Details .....	25
Trestle Tables .....	11-12	Table Options.....	26
Cabinet Base Tables.....	12	Information .....	27
Benches.....	13	Self Store .....	28-30
Butterfly Tables .....	14-16	Locks.....	31
Quick Ship Items .....	17	Fabric & Leather Benches .....	32
Collections.....	18-22	Large Extension Tables.....	33

## TABLES

Addison Single.....	34	Bridgeport Trestle.....	66
Advance Single.....	35	Brinkley Trestle .....	69
Alana Single.....	38	Broadway Leg .....	72
Albany Single .....	39	Brooklyn Single .....	74
Arts & Crafts Cabinet.....	40	Brookville Single .....	75
Arts & Crafts Single .....	41	Brookville Single Pub .....	76
Arts & Crafts Single Pub .....	42	Burlington Double .....	77
Arts & Crafts Trestle .....	43	Burlington Single.....	80
Auburn Double.....	45	Cambridge Trestle.....	82
Auburn Single.....	46	Canterbury Leg.....	86
Avery Trestle.....	47	Carson Single .....	88
Barrington Double .....	50	Century Cabinet.....	89
Barrington Single.....	51	Chancellor Double .....	92
Bassett Cabinet .....	52	Chancellor Single .....	93
Baytown Double .....	53	Chesapeake Trestle .....	94
Baytown Single.....	58	Cheyenne Leg.....	96
Bennington Leg .....	59	Colby Leg .....	98
Berkshire Leg .....	62	Colebrook Trestle .....	99
Braden Trestle.....	63	Columbus Trestle .....	103
Brady Leg .....	65	Dallas Trestle .....	107
		Dayton Leg.....	108

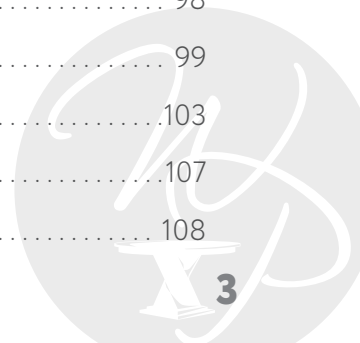

# TABLE OF CONTENTS (continued)

Denver Leg.....	109	Laurie’s Leg .....	164
Dover Leg.....	113	Lexington Double.....	165
Durango Trestle.....	116	Lexington Leg Mini.....	168
Dutch Double.....	119	Lexington Leg.....	170
Easton Single.....	120	Lexington Single Mini.....	172
El Paso Trestle.....	121	Lexington Single.....	173
Ellianna Cabinet.....	125	Lexington Trestle.....	176
Ellianna Leg.....	128	Lexington Cabinet.....	177
Elwood Leg.....	129	Live Edge table with metal bases.....	178
Ethan Leg.....	130	Live Edge Rough Sawn table w/metal bases.....	182
Fenway Trestle Pub.....	131	Livingston table with metal bases.....	186
Fort Worth Single.....	132	Logan Trestle.....	188
Fremont Trestle.....	133	Madison Leg Pub.....	190
Fulton Trestle.....	134	Mankato Trestle.....	191
Galena Trestle.....	135	Mansfield Leg.....	195
Hampton Leg.....	139	McCoy Trestle.....	196
Hampton Trestle.....	140	Mission Leg.....	198
Harrison Double.....	142	Mission Trestle.....	199
Harrison Single.....	143	Monarch Cabinet.....	201
Hartford Trestle.....	144	Naperville Trestle.....	202
Harvest Leg.....	145	Nashville Trestle.....	203
Heidi Cabinet.....	147	Newark Leg.....	205
Heidi Leg.....	152	Newbury Leg.....	209
Imperial Double.....	156	Nora Single.....	213
Imperial Single.....	157	Olde Century Mission Trestle.....	214
Imperial Single Pub.....	158	Orewood Trestle.....	218
Jamestown Trestle.....	159	Plymouth Leg Drop Leaf.....	219
Kingsbury Mission Trestle.....	160	Portland Single.....	222
Lamesa Trestle.....	161	Preston Double.....	223
Laporte Trestle.....	162	Preston Single.....	224

# TABLE OF CONTENTS (continued)

Reno Trestle . . . . .	225	Traditional Double . . . . .	249
Ridgecrest Double . . . . .	229	Traditional Double Scallop . . . . .	250
Ridgewood Single . . . . .	230	Traditional Leg . . . . .	251
Santa Fe Leg . . . . .	231	Traditional Single Pub . . . . .	252
Saratoga Trestle . . . . .	235	Traditional Single . . . . .	253
Shelby Trestle . . . . .	238	Tulsa Cabinet . . . . .	256
Sheridan Trestle . . . . .	239	Vancouver Trestle . . . . .	257
Sierra Trestle . . . . .	243	Wabash Barrel Single . . . . .	260
Sonoma Single . . . . .	246	Wellington Trestle . . . . .	261
Stanwood Leg . . . . .	247	Westin Single . . . . .	264
Sydney Trestle . . . . .	248		

## **BENCHES**

Arts & Crafts Bench . . . . .	44	Heidi Bench . . . . .	153
Braden Bench . . . . .	64	Laporte Bench . . . . .	163
Bridgeport Bench . . . . .	68	Lexington Bench . . . . .	169
Broadway Bench . . . . .	73	Live Edge bench with metal base . . . . .	179
Cambridge Bench . . . . .	83	Live Edge Rough Sawn bench w/metal bases . . . . .	183
Canterbury Bench . . . . .	87	Livingston bench with metal bases . . . . .	187
Chesapeake Bench . . . . .	95	Logan Bench . . . . .	189
Cheyenne Bench . . . . .	97	Mankato Bench . . . . .	194
Colebrook Bench . . . . .	102	McCoy Bench . . . . .	197
Columbus Bench . . . . .	106	Mission Bench . . . . .	200
Denver Bench . . . . .	112	Nashville Bench . . . . .	204
Durango Double Bench . . . . .	117	Newark Bench . . . . .	208
Durango Triple Bench . . . . .	118	Newbury Bench . . . . .	212
El Paso Bench . . . . .	124	Olde Century Bench . . . . .	215
Galena Bench . . . . .	138	Reno Bench . . . . .	228
Hampton Bench . . . . .	141	Santa Fe Bench . . . . .	234
Harvest Bench . . . . .	146	Sheridan Bench . . . . .	242

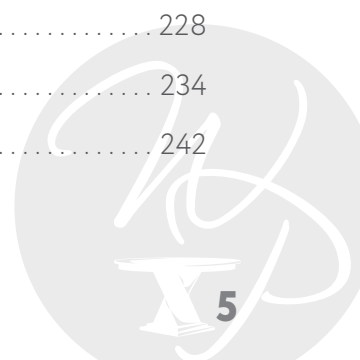

# NEW PRODUCTS FOR 2025



Auburn Double



Auburn Single



Bennington Leg



Burlington Double



Century Cabinet



Colby Leg



Durango Trestle



Ellianna Cabinet



Elwood Leg



Fort Worth Single



Lexington Double



Monarch Cabinet



Newark Leg



Nora Single



Sydney Trestle



Durango Double Bench



Durango Triple Bench



Newark Bench

# DISCONTINUED PRODUCTS



Kingsley Single



Knoxville Trestle



Laredo Trestle



Oxford Double Pedestal



Ravena Trestle



Richland Trestle



Savannah Single



Laredo Bench



# LIVE EDGE PROGRAM



Livingston top with Lifestyle Trestle base



Livingston top with Lifestyle Bench base



Live Edge top with Pagosa Trestle base



Live Edge top with Pagosa Bench base



Live Edge Rough Sawn top with El Dorado Trestle base



Live Edge Rough Sawn top with El Dorado Bench base



Live Edge top with Xavier Trestle base



Live Edge top with Xavier Bench base



Live Edge top with Martin Trestle Pub base

# WOOD & HUMIDITY

The photo below is an example of what can happen to a table with humidity changes. This is not a defect, it is the result of natural movement in wood. Please see page 24 for more information regarding wood movement.

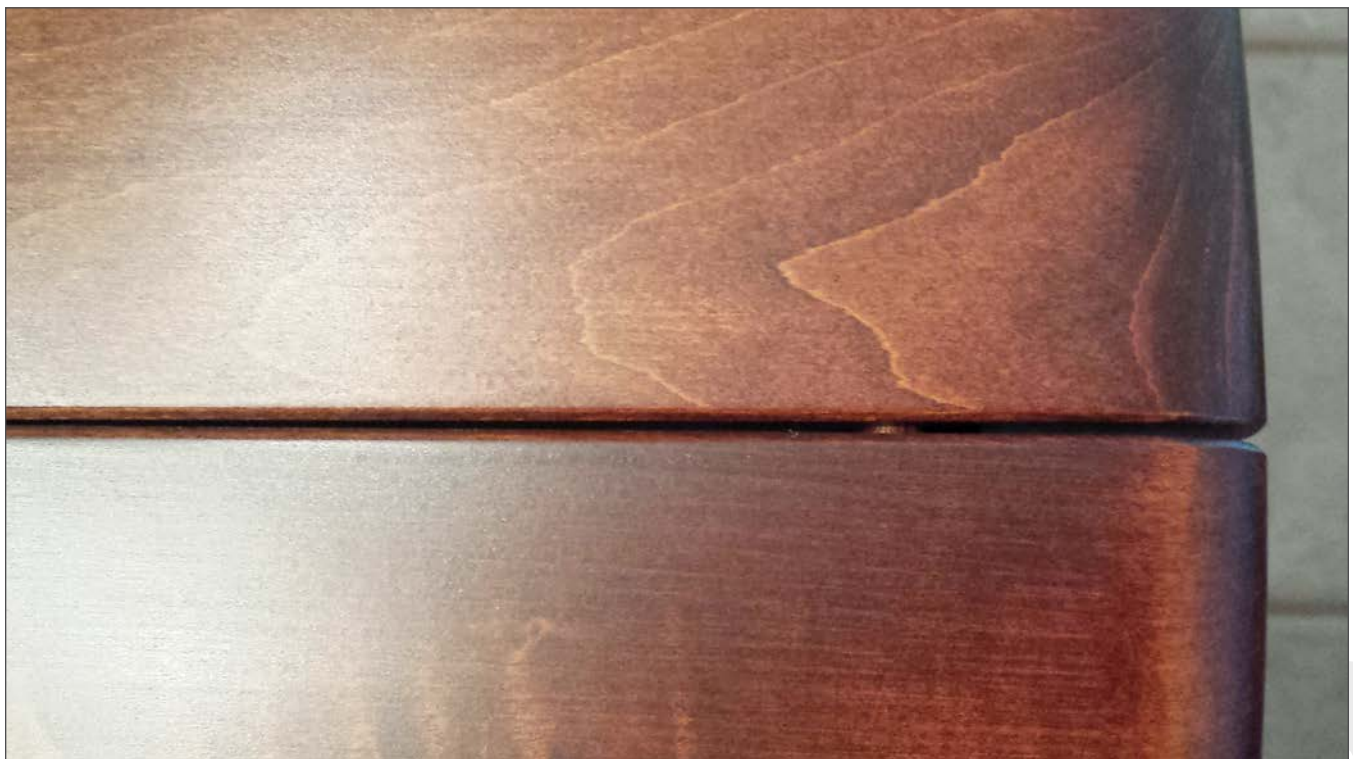

The photo above is the result of too low humidity, creating a gap at the ends of the joints. If the humidity is too high, the table will gap at the center of the joints.

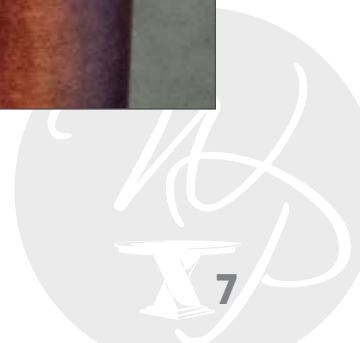

# SINGLE PEDESTAL TABLES



Addison Single



Advance Single



Alana Single



Albany Single



Arts & Crafts Single



Arts & Crafts  
Single Pub



Auburn Single



Barrington Single



Baytown Single



Brooklyn Single



Brookville Single



Brookville Single Pub



Burlington Single



Carson Single



Chancellor Single



Easton Single



Fort Worth Single



Harrison Single



Imperial Single



Imperial Single Pub



Lexington Single



Lexington  
Single Mini



Nora Single



Portland Single



Preston Single



Ridgewood Single



Sonoma Single



Traditional Single Pub



Traditional Single



Wabash Barrel Single



Westin Single

# DOUBLE PEDESTAL TABLES



Auburn Double



Barrington Double



Baytown Double



Burlington Double



Chancellor Double



Dutch Double



Harrison Double



Imperial Double



Lexington Double



Preston Double



Ridgecrest Double



Traditional Double



Traditional Double  
Scallop



# LEG TABLES



Bennington Leg



Berkshire Leg



Brady Leg



Broadway Leg



Canterbury Leg



Cheyenne Leg



Colby Leg



Dayton Leg



Denver Leg



Dover Leg



Ellianna Leg



Elwood Leg



Ethan Leg



Hampton Leg



Harvest Leg



Heidi Leg



Laurie's Leg



Lexington Leg



Lexington Leg Mini



Madison Leg Pub



Mansfield Leg



Mission Leg



Newark Leg



Newbury Leg



Plymouth Leg Drop Leaf



Santa Fe Leg



Stanwood Leg



Traditional Leg



# TRESTLE TABLES



Arts & Crafts Trestle



Avery Trestle



Braden Trestle



Bridgeport Trestle



Brinkley Trestle



Cambridge Trestle



Chesapeake Trestle



Colebrook Trestle



Columbus Trestle



Dallas Trestle



Durango Trestle



El Paso Trestle



Fenway Trestle Pub



Fremont Trestle



Fulton Trestle



Galena Trestle



Hampton Trestle



Hartford Trestle



Jamestown Trestle



Kingsbury Mission Trestle



Lamesa Trestle



Laporte Trestle



Lexington Trestle



Live Edge top with  
Martin Trestle Pub base



Live Edge top with  
Pagosa Trestle base



Live Edge top with  
Xavier Trestle base



Live Edge rough sawn  
top with El Dorado  
Trestle base



Livingston top with  
Lifestyle Trestle base



Logan Trestle



Mankato Trestle



McCoy Trestle



Mission Trestle

# TRESTLE TABLES (continued)



Naperville Trestle



Nashville Trestle



Olde Century Mission Trestle



Orewood Trestle



Reno Trestle



Saratoga Trestle



Shelby Trestle



Sheridan Trestle



Sierra Trestle



Sydney Trestle



Vancouver Trestle



Wellington Trestle

# CABINET BASE TABLES



Arts & Crafts Cabinet



Bassett Cabinet



Century Cabinet



Ellianna Cabinet



Heidi Cabinet



Lexington Cabinet



Monarch Cabinet



Tulsa Cabinet

# BENCHES



Arts & Crafts Bench



Braden Bench



Bridgeport Bench



Broadway Bench



Cambridge Bench



Canterbury Bench



Chesapeake Bench



Cheyenne Bench



Colebrook Bench



Columbus Bench



Denver Bench



Durango Double Bench



Durango Triple Bench



El Paso Bench



Galena Bench



Hampton Bench



Harvest Bench



Heidi Bench



Laporte Bench



Lexington Bench



Live Edge top with Pagosa Bench base



Live Edge top with Xavier Bench base



Live Edge rough sawn top with El Dorado Bench base



Livingston top with Lifestyle Bench base



Logan Bench



Mankato Bench



McCoy Bench



Mission Bench



Nashville Bench



Newark Bench



Newbury Bench



Olde Century Bench



Reno Bench



Santa Fe Bench



Sheridan Bench

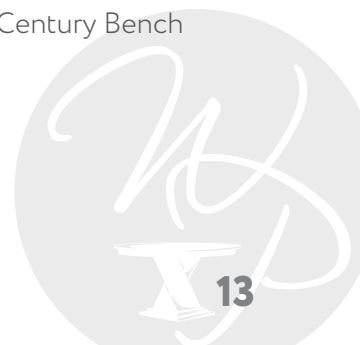

# BUTTERFLY LEAF TABLES

## LEG TABLES

- Leg tables available with only one 18" butterfly leaf
- 42" is minimum width for butterfly leaf table
- Not available with 4" Clip Corner top shape
- Butterfly leaf tables are not available in custom widths



Broadway Leg



Canterbury Leg



Denver Leg



Heidi Leg



Madison Leg Pub



Mansfield Leg



Mission Leg



Newbury Leg



Traditional Leg

## CABINET BASE TABLES

- Cabinet base tables are standard with 1-18" butterfly leaf
- Cabinet base tables are not available with 2 butterfly leaves



Arts & Crafts Cabinet



Bassett Cabinet



Century Cabinet



Ellianna Cabinet



Heidi Cabinet



Lexington Cabinet



Monarch Cabinet



# BUTTERFLY LEAF TABLES

## TRESTLE TABLES

- See page 25 for close-up view of a Butterfly Table
- 42" x 60" & 48" x 60" 1-18" butterfly leaf only due to short base
- 42" x 66", 42" x 72", 48" x 66", & 48" x 72" available with one or two 18" butterfly leaves
- 42" is minimum width for butterfly leaf table
- Butterfly leaf tables are not available in custom widths



Arts & Crafts Trestle



Brinkley Trestle



Cambridge Trestle



Colebrook Trestle



Fremont Trestle



Galena Trestle



Jamestown Trestle



Kingsbury Mission Trestle



Lexington Trestle



McCoy Trestle



Mission Trestle



Naperville Trestle



Nashville Trestle



Olde Century  
Mission Trestle



Reno Trestle



Sierra Trestle



Vancouver Trestle

# BUTTERFLY LEAF TABLES

## SINGLE PEDESTAL TABLES

- Single pedestal tables available with only one 18" butterfly leaf
- Only available in 48" and 54" round
- Not available in custom sizes
- Only available in 18" leaf
- Only available with 1" thick top
- Leaf skirts not available



Alana Single



Albany Single



Arts & Crafts Single



Arts & Crafts Single Pub



Auburn Single



Baytown Single



Brookville Single



Brookville Single Pub



Carson Single



Chancellor Single



Easton Single



Harrison Single



Imperial Single



Imperial Single Pub



Lexington Single



Nora Single



Portland Single



Preston Single



Ridgewood Single



Traditional Single

# QUICK SHIP ITEMS

- These items are available in Quick Ship
- *NOTE: the edge, shape and S/S options cannot be changed on Quick Ship items*
- We reserve the right to remove any item from the Quick Ship program without prior written notice
- **NEW options: Ellianna Leg and Plymouth Leg  
Denver Leg and Lexington Leg in Rustic Hickory**



Baytown Single  
42" Round, 2 leaf  
Brown Maple



Burlington Single  
60" Round, Solid Top  
Brown Maple or  
Rustic Cherry



Columbus Bench  
72", 2 leaf  
Rough Sawn  
Wormy Maple



Columbus Trestle  
42" X 72", 2 leaf, S/S  
Rough Sawn  
Wormy Maple



Denver Leg  
42" X 72", 2 leaf, S/S  
Oak or Rustic Hickory



Dover Leg  
36" X 48", 2 leaf, S/S  
Oak or Brown Maple



El Paso Bench  
80", 2 leaf  
Rough Sawn Wormy Maple



El Paso Trestle  
48" X 80", 2 leaf  
Rough Sawn Wormy Maple



Ellianna Leg  
42" X 72", 2 leaf, S/S  
Oak or Brown Maple



Galena Trestle  
42" X 72", 2 leaf, S/S  
QSWO or Rustic Hickory



Imperial Single  
48" Round, 2 leaf  
Brown Maple



Lexington Leg  
42" X 72", 2 leaf, S/S  
Br. Maple or R. Hickory



Live Edge Table  
w/Xavier Base  
*see page 178 for  
more base options*  
42" X 84" Solid Top  
Rustic Walnut



Live Edge Bench  
w/Xavier Base  
*see page 179 for  
more base options*  
84" Solid Top  
Rustic Walnut



Lexington Single  
54" Round, 2 leaf  
Brown Maple



Newbury Leg  
42" X 60", 2 leaf, S/S  
Brown Maple



Plymouth Leg Drop Leaf  
36" X 32", drop leaves  
Solid Top, Oak



Sheridan Trestle  
36" X 54", 2 leaf, S/S  
Oak



# COLLECTIONS



Alana Single - pg. 38



Avery Trestle - pg. 47



Baytown Double - pg. 53



Baytown Single - pg. 58



Berkshire Leg - pg. 62



Bridgeport Trestle - pg. 66



Brinkley Trestle - pg. 69



Burlington Double - pg. 77



# COLLECTIONS



Burlington Single - pg. 80



Canterbury Leg - pg. 86



Chancellor Double - pg. 92



Colebrook Trestle - pg. 99



Columbus Trestle - pg. 103



Denver Leg - pg. 109



Dover Leg - pg. 113



El Paso Trestle - pg. 121

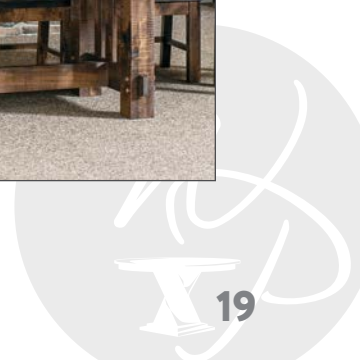



# COLLECTIONS



Ellianna Leg - pg. 128



Galena Trestle - pg. 135



Heidi Cabinet - pg. 147



Heidi Leg - pg. 152



Imperial Double - pg. 156



Lexington Double - pg. 165



Lexington Leg - pg. 170



Lexington Single - pg. 173



# COLLECTIONS



Live Edge Table w/Xavier Base - pg. 178



Live Edge Rough Sawn Table w/El Dorado Base - pg. 182



Mankato Trestle - pg. 191



Newark Leg - pg. 205



Newbury Leg - pg. 209



Orewood Trestle - pg. 218



Portland Single - pg. 222



Reno Trestle - pg. 225

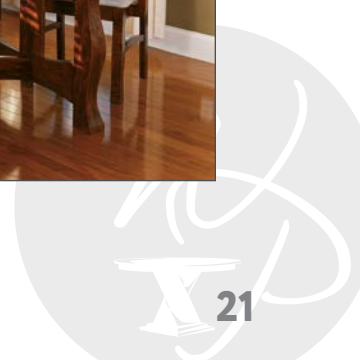



# COLLECTIONS



Santa Fe Leg - pg. 231



Saratoga Trestle - pg. 235



Sheridan Trestle - pg. 239



Sonoma Single - pg. 246



Tulsa Cabinet - pg. 256



Wabash Barrel Single - pg. 260



Wellington Trestle - pg. 261



# EXCELLENT SELLERS



Addison Single



Baytown Double



Baytown Single



Bridgeport Trestle



Broadway Leg



Brookville Single



Burlington Single



Canterbury Leg



Colebrook Trestle



Columbus Trestle



Denver Leg



Dover Leg



El Paso Trestle



Ethan Leg



Galena Trestle



Heidi Leg



Imperial Double



Imperial Single



Lexington Leg



Lexington Leg Mini



Lexington Single



Live Edge Table with  
Xavier Base



Mankato Trestle



Mission Trestle



Newbury Leg



Olde Century Mission Trestle



Plymouth Leg Drop Leaf



Sheridan Trestle

## THE NATURE OF WOOD

Wood is a product of nature and therefore acts in ways beyond human control. All hardwood has variation in its color and grain. These wood characteristics will put their own unique touch to each piece of solid wood furniture. Even though we go through the same building process, no two pieces will be exactly the same. Wood color can vary a lot depending on stain selection.

Most hardwoods are open grained, causing solid wood furniture to expand and contract with changes in temperature and humidity, even after protective finishes have been applied. These temperature changes may cause the wood to crack or have surface checks. This is not abnormal and these are not considered as flaws, but rather nature's "beauty marks" which make

each piece manufactured at West Point Woodworking a truly unique piece of furniture.

Indoor humidity should be kept in the 35-40% range to minimize these effects. Solid wood should be kept away from direct sources of heating and cooling and should not be stored in attics or basements. Direct sunlight and fluorescent fixtures that contain ultraviolet rays can cause chemical changes in wood and finish and therefore should be avoided.

When cared for properly your solid wood furniture will become a piece of timeless beauty, one that will be treasured for generations.

## ORDERING INFORMATION

To avoid delays in production and unnecessary phone calls, please provide the following information on all table orders.

1. QUANTITY
2. STYLE
3. SIZE
4. LEAVES: with skirts or without skirts
5. SHAPE OF TOP: if options are available
6. EDGE STYLE: if the shape of top or edge is not specified, we will proceed with the standard specs for that style
7. BASE STYLE: single pedestal, double pedestal, leg
8. FEET STYLE: if options are available
9. SELF STORE: if available
10. WOOD SPECIE
11. STAIN COLOR: if available at time of order
12. YOUR PURCHASE ORDER NUMBER
13. CUSTOMER NAME
14. YOUR FINISHER...so we know where to ship your tables!

***Thank You!***

## WARRANTY POLICY

**UPDATED 2025**

At West Point Woodworking we are pleased that you have chosen to invest in hardwood furniture. Our tables are built entirely out of hardwoods from the top to bottom. You will not find any particle board or veneers, with the exception of some parts of the cabinet base. We use some plywood in places where it would not be practical to use solid hardwoods due to expansion and contraction of solid wood. We offer a 5 year warranty on workmanship, materials, and construction methods. If a defect is found in the first 5 years of when the table was built, and the table has not been abused or improperly cared for, we will repair the table at no cost. If the table has been damaged due to improper care we can still repair the table and will do so at a reasonable fee (usually \$100, depending on damage).

Always keep in mind that wood is a natural product and can expand or contract under certain humidity conditions. When the humidity is too high (above 50%) you may see some gaps between the leaves toward the center of the table. If the humidity level drops below 35% you may notice a little gap between the leaves towards the outer edge of the leaves. Most of the time this is nothing to be alarmed about and you may see the table go through this as the seasons change, especially if the house is not humidity controlled. If there is enough expansion or contraction in the table top to actually cause the wood to split, we will repair the table in the first 5 years unless it was improperly cared for. Finishing and shipping back and forth for repairs is not included in the warranty. If the table splits after 5 years from the manufacturing date, there will be a minimum charge of \$100 to repair the table and send it to the finish shop. Finishing cost will have to be negotiated between the retail store and the finisher.

# ATTENTION TO DETAILS

West Point Woodworking pays attention to special details. Quality and details are important to us. Quality standards are established to ensure trouble free service. Each table is made-to-order and our craftsmen will follow your specifications from start to finish.

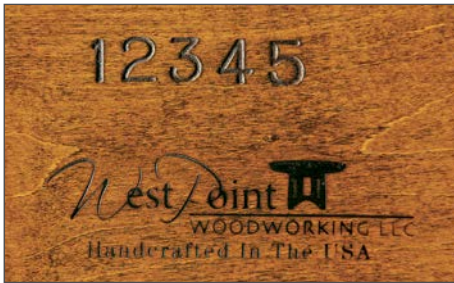

Each table is assigned a serial number for tracking purposes should any questions or problems arise.



V-grooved corner block assembly and two bolt leg attachments are part of the quality construction of our tables.



Quarter Sawn is created by using a different sawing technique to expose the different grains in the wood bringing out the flakes that remind us of family heirlooms.



Self-storing tables are designed to conveniently store extra leaves. Quality gear slides are used to help you open your table easily.



Butterfly leaf table option. See pages 14 – 16 for available styles.



# OPTIONS

## TABLE EDGE DESIGNS



5/8" **ROUNDOVER**



**BEVEL**



**MISSION** (1/8" *Roundover*)



**CHAMFER**



**OGEE**



**WATERFALL**

## TABLE TOP OPTIONS



*For Pedestals  
or Trestles*

**8" SQUARE  
ROUND**



**RECTANGLE**



*1" or 4"  
Radius available*

**RADIUS  
CORNER**

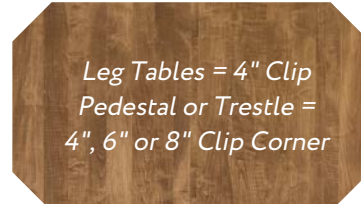

*Leg Tables = 4" Clip  
Pedestal or Trestle =  
4", 6" or 8" Clip Corner*

**CLIPPED  
CORNERS**



*Not Available  
on Leg Tables*

**OVAL**



**BOW  
END**



*Not Available  
on Leg Tables*

**BANQUET**



**BOAT**



**ROUND**



# INFORMATION

## INTERNET POLICY

We require a minimum markup on the **West Point Finished Wholesale price list**. Please see our pricelist for more details.

We firmly believe that the products we are building are far superior to many of the imports and other cheap lines of furniture that are on the market today, and by selling at too low price devalues this level of craftsmanship.

We are pleased that you have chosen to represent our 100% American made products and ask that you promote these products with confidence and truly believe in the product and sell it for what it is worth.

**Steve Raber**



## CARE OF SOLID WOOD TABLES

If cared for properly your solid hardwood table can give you a lifetime of service and beauty. Here are several care tips that will enhance your solid hardwood table investment:

- Place your table away from radiators, fireplaces, and heating ducts.
- Position table out of direct sunlight or adjust blinds to avoid hour after hour of direct sunlight.
- Control humidity to 40%–45%. In winter use a humidifier, in summer use a dehumidifier or air conditioner.
- Use coasters with non-scratching bottoms.
- Use padding under all sharp, hot, or cold objects.
- Store table leaves in close proximity to table or in the same humidity, avoid storing leaves in damp basements where the leaves may swell.
- Avoid using nail polish remover, alcohol, and other solvents near or on table.

## ROUTINE CLEANING AND CARE

**DUST CAREFULLY** with a soft cloth, following the grain pattern of the wood. Use an old T-shirt, baby diaper or cheesecloth that has been laundered to remove the sizing.

**DUST OFTEN** to remove everyday abrasive particles from wood surfaces.

**CONSIDER CLEANING** with a mild nonalkaline soap and water. Use the suds in a damp sponge or cloth, but be sure to pre-test the solution on an out-of-sight section to make sure it doesn't damage the finish. Dry immediately with a soft cloth and buff lightly, following the grain.

**DON'T WAX** or use any polish that contains any silicones! Catalyzed heat and moisture resistant finishes don't need additional polish, but if you want to use a polish we recommend Guardsman Furniture Polish.

## REAL OR IMITATION?

Not sure if you're buying solid hardwood or a chip imitation? A check point is the glue joints. Put your finger on a glue joint and trace it along the top of the surface, over the edge, and to the underside. If the line disappears its probably an imitation. Solid hardwood joints on the other hand can be traced across the top, the side and the underside.



# SELF STORE

*Please refer to price list first to see if any specific self-store rules apply to that table style. If no additional info is listed, you may use this page as a general guide. Please note that custom sizes and changing the top shape can affect self-store capabilities. Tops must be 12" longer than width in order to self-store.* In an effort to clear up some confusion that can go with self storing tables, we are providing a general list of table sizes, shape and styles where self storing works or does not work. Always keep in mind when you are selling a table and self storing is requested, there are two major factors in self storing:

- 1) pedestal or trestle base mounting plate size and spacing
- 2) the length of the table slide required to accommodate the amount of leaves needed for the table.

Here is one example of a very common size table that gets ordered self store, but it cannot self store four leaves: 42" x 66" OVAL, 4 leaves. Most people have a tendency to think that the three leaf version can self store all three of the leaves, so it shouldn't be a problem to store four leaves on a four leaf table, however this does not work because for a four leaf table, our slide is 12" longer than on a three leaf table, which forces us to move the slides closer together so they fit between the table skirts. Then there is not enough space between the slides to store more than two leaves.

## GENERAL INFORMATION

### TRESTLE TABLES WITH RECTANGLE OR BOW END TOPS

- 42" x 60" stores up to 4 leaves, ALL unskirted
- 42" x 66" and 42" x 72" stores up to 4 leaves, 2 with skirts, 2 without
- 48" x 60" stores up to 4 leaves, 2 with skirts, 2 without
- 48" x 66" and 48" x 72" stores up to 4 leaves, ALL unskirted

### TRESTLE TABLES WITH BOAT SHAPE TOPS

- 42" x 60" – 1, 2, 3 and 4 leaf tables can only self store 2 leaves BOTH without skirts
- 42" x 66" and 42" x 72" stores up to 4 leaves, 2 with skirt and 2 without
- 48" x 60" stores up to 4 leaves, 2 with skirt, 2 without
- 48" x 66" and 48" x 72" stores up to 4 leaves, ALL unskirted

### DOUBLE PEDESTAL TABLES WITH RECTANGLE, BOW END, AND SQUARE ROUND TOPS

- Any 42" or 48" wide table can self store up to 4 leaves, 2 with skirt, 2 without.

**\*\*NOTE: SQUARE OR ROUND TABLES CANNOT SELF STORE ANY LEAVES!**

### DOUBLE PEDESTAL TABLES WITH OVAL AND BANQUET TOPS

- 42" x 54" stores up to 2 leaves, 1 with skirt, 1 without
- 48" x 54" – 48" w leaf does not fit inside of a 54" long oval top
- 42" x 60" – 1, 2 and 3 leaf oval tables store 2 leaves, 1 with skirt, 1 without
- 42" x 60" – 1, 2 and 3 leaf banquet tables store 2 skirted leaves
- 42" x 60" – 4 leaf table cannot store any leaves
- 42" x 66" – 1, 2 and 3 leaf tables store up to 3 leaves, 2 with skirts, 1 without
- 42" x 66" – 4 leaf table can store 2 leaves, 1 with skirt and 1 without.
- 42" x 72" – 1, 2 and 3 leaf tables store up to 3 leaves, 2 with skirts, 1 without
- 42" x 72" – 4 leaf oval table can only store 2 leaves, 1 with skirt, 1 without
- 42" x 72" – 4 leaf banquet table can store up to 4 leaves, 2 with skirts, 2 without
- 48" x 60" – 1, 2, and 3 leaf tables can only store 2 leaves, 1 with skirt, 1 without
- 48" x 60" – 4 leaf table cannot store any leaves
- 48" x 66" – 1, 2, and 3 leaf tables store up to 3 leaves, 2 with skirts, 1 without
- 48" x 66" – 4 leaf table can only store 2 leaves, 1 with skirt, 1 without
- 48" x 72" self stores up to 4 leaves, 2 with skirts, 2 without

# SELF STORE

## TRESTLE TABLES

42" Leaf (Skirts fit between plates)

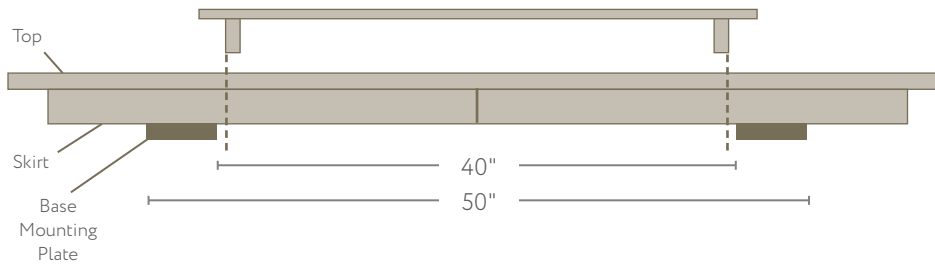

SIDE VIEW OF:  
42" x 66" and 42" x 72"  
Trestle Table

- Can store up to 4 leaves,  
2 with skirt, 2 without

42" Leaf (Skirts come on top of the plates)

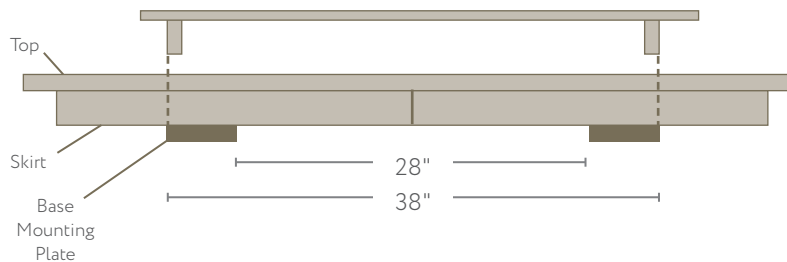

SIDE VIEW OF:  
42" x 60" Trestle Table

- Can store up to 4 leaves,  
ALL unskirted

48" Leaf (Skirts go on the outside of the plates)

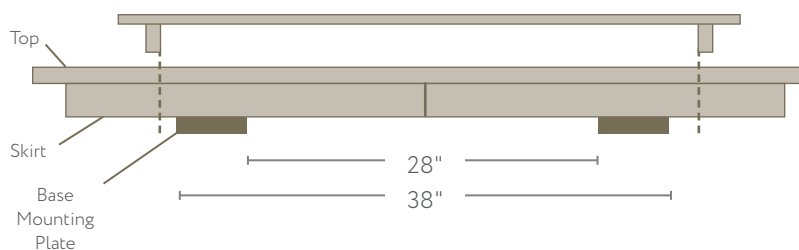

SIDE VIEW OF:  
48" x 60" Trestle Table

- Can store up to 4 leaves,  
2 with skirt, 2 without

48" Leaf (Skirts come on top of the plates)

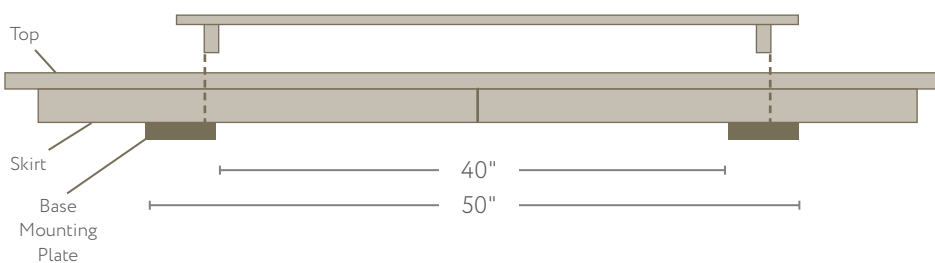

SIDE VIEW OF:  
48" x 66" and 48" x 72"  
Trestle Table

- Can store up to 4 leaves,  
ALL unskirted

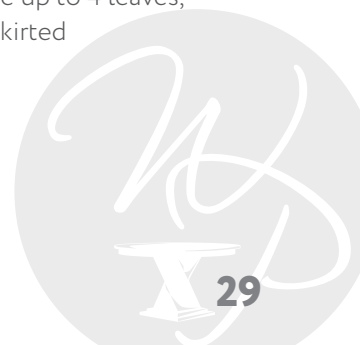

# SELF STORE

Here are two examples of oval tables that can or cannot self store.

## **BOTTOM VIEW OF TABLE:**

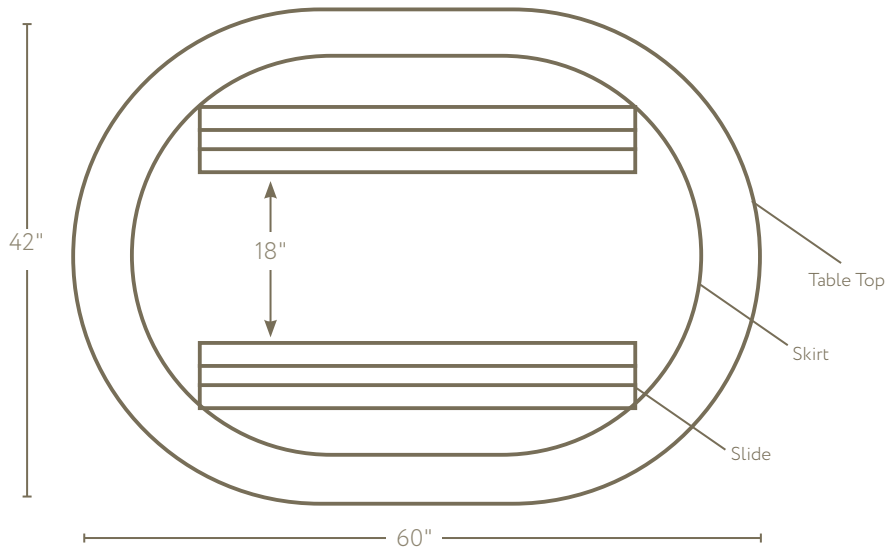

42" x 60" - 3 LEAVES.  
Only 1 leaf fits between the slides, so table can only store 2 leaves. 1 leaf on top of the other, 1 with skirt, 1 without.

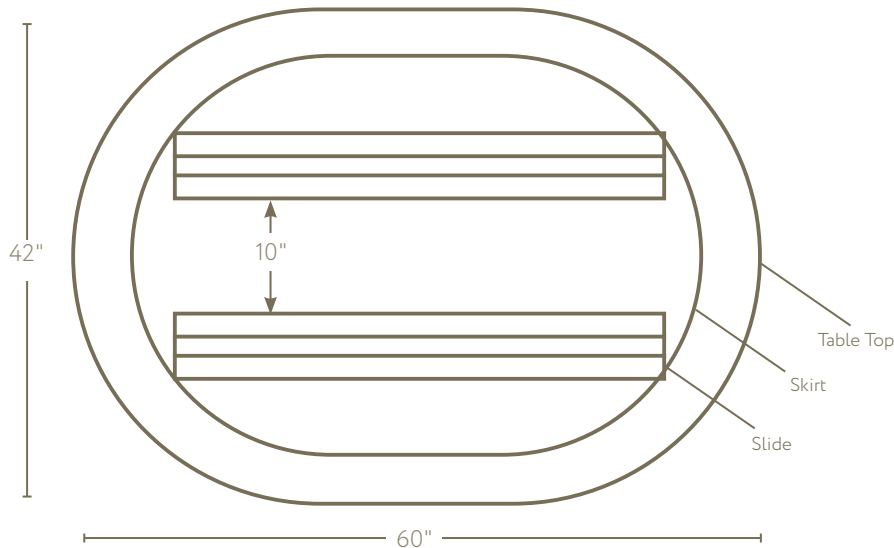

42" x 60" - 4 LEAVES.  
Tables slide is 50" long and the table is only 60" long and with the oval shape it pushes the slides in so that there is only 10" max between the slides, therefore this table CANNOT store any of the 4 leaves.

The drawings above hold true for 42" x 66" 3 and 4 leaf tables as far as the length of the slides, however a 42" x 66" 3 leaf double pedestal table has enough space between the slide to store 2 leaves side by side and 1 on top, 2 with skirts, 1 without.

When a 4 leaf slide is used on a 42" x 66" 4 leaf table the slides have to be moved in because of the oval shape which then will only allow 18" between the

slides, therefore this table can only store 2 leaves, 1 with skirt, 1 without. The 2 leaves that cannot store will be skirted.

There are more examples that could be shown here, but we hope our efforts to list the basic "rules" of self storing will help our dealers and their customers to understand why some tables self store leaves and others do not.



## LOCKS

**Leverlocks:** All tables are standard with a leverlock in the center of the table, however ANY table that is ordered with the self store feature will not have a leverlock unless it is special ordered. The lock is removed so that the “catch” part of the lock does not scratch the leaves as they are being put in the self store position.

**Leaf Locks:** We use a spring lock. These locks are user friendly and adjust well to any movement that will occur naturally with wood products. **Not standard.**

**PLEASE NOTE:** If self storing and leaf locks are options that your customer is requesting, we highly recommend that they decide which of the 2 options is the most important to them. On certain models of tables, the locks will be right on the plate which takes away space to store 2 leaves on top of each other. As a manufacturer of tables we do not recommend any type of leaf lock, as it is just another piece of hardware that can scratch your beautiful hardwood table.

---

## RUSTIC WOODS

When ordering Rustic Wood tables, please be aware that these tables come standard with filled knots on the table top. We make no guarantees of the size, quantity, or type of knots that a table has. If you want open knots, please specify.



Small Open Knot



Small Knot with Black Epoxy



Large Open Knot



Medium Open Knot



Medium Knot with Black Epoxy

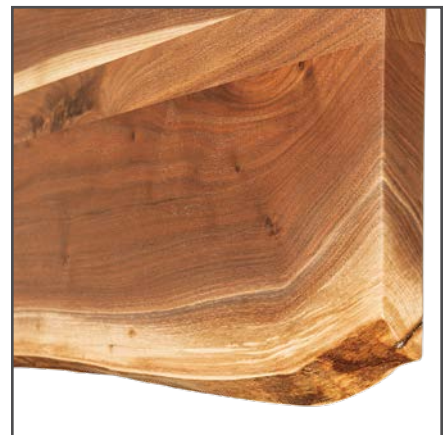

Live Edge Tops will have Filled Knots



# FABRIC & LEATHER BENCH TOP OPTIONS



- Only available on solid top benches that have skirting (see list below)
- 72" is max. length
- Available in any Heartland Fabric selection
- Denver Bench shown in Brown Maple with FC-42000 Almond stain and R1-105 Black fabric (*Note: Actual color may vary from picture*)
- For pricing, see page 5 of pricelist



## AVAILABLE ON THESE BENCHES

Arts & Crafts	Chesapeake	Hampton	Mission	Santa Fe
Braden	Cheyenne	Harvest	Newark	Sheridan
Bridgeport	Colebrook	Heidi	Newbury	
Broadway	Columbus	Lexington	Nashville	
Cambridge	Denver	Logan	Olde Century	
Canterbury	Galena	McCoy	Reno	

## NOT AVAILABLE ON THESE BENCHES

Durango Triple	El Paso	Live Edge	Livingston
Durango Double	Laporte	Live Edge Rough Sawn	Mankato

# LARGE EXTENSION TABLE OPTION



- Up to 12-12" leaves available on select trestle, double pedestal, and leg tables that reference this page
- NOT available with self store
- NOT available in pub or bar height
- NOT available with boat shape
- NOT available in 42" X 60" Oval shape
- NOT available with gear slides or ball bearing slides
- Only available in 30" height
- 42" wide is minimum width
- 60" long is minimum length
- All leaves will have skirts, unless otherwise specified
- Trestle and double pedestal tables will have drop legs on the ends for support (fold up when not in use)
- Leg tables will have 2 center legs with 5 to 7 leaves and 4 center legs with 8 to 12 leaves
- For pricing, see page 4 of pricelist

## TRESTLE TABLE SHOWING DROP LEGS

- Galena Trestle 42" X 72" with 8-12" leaves; shown in QSWO with Michael's Cherry stain  
*(Note: Actual color may vary from picture)*



## LEG TABLE SHOWING EXTRA CENTER LEGS

- Lexington Leg 42" X 72" with 8-12" leaves; shown in Brown Maple with Almond stain  
*(Note: Actual color may vary from picture)*



# ADDISON SINGLE

- 1" Round or Oval top with Mission edge standard
- Base standard as shown with levelers
- Not available in pub height
- Floor to bottom of skirt 26½"
- Shown in QSWO with FC-42633 Manchester stain  
(Note: Actual color may vary from picture)



## SIZES

30" X 42" Oval      Up to 2-10" leaves      Stores up to 2 unskirted leaves  
36" X 36" Round      Up to 2-10" leaves

## SPECIES

BROWN MAPLE • RED OAK • QSWO • CHERRY • HARD MAPLE • HICKORY • RUSTIC CHERRY • RUSTIC HICKORY • RUSTIC QSWO  
RUSTIC WALNUT • SAP CHERRY • WALNUT • WORMY MAPLE • PLAIN SAWN WHITE OAK • RUSTIC PLAIN SAWN WHITE OAK

## SHAPE OPTIONS



ROUND



OVAL

## EDGE OPTIONS



MISSION  
(STANDARD)



5/8" ROUNDOVER



WATERFALL



BEVEL



CHAMFER



# ADVANCE SINGLE

- 1" Round or Oval top with Mission edge standard
- Base standard as shown with levelers
- Not available in pub height
- Floor to bottom of skirt 26½"
- Shown in Oak with FC-9018 Lite Asbury stain  
(Note: Actual color may vary from picture)



## SIZES

- |                 |                    |                                 |
|-----------------|--------------------|---------------------------------|
| 30" X 42" Oval  | Up to 2-10" leaves | Stores up to 2 unskirted leaves |
| 36" X 36" Round | Up to 2-10" leaves |                                 |

## SPECIES

BROWN MAPLE • RED OAK • QSWO • CHERRY • HARD MAPLE • HICKORY • RUSTIC CHERRY • RUSTIC HICKORY • RUSTIC QSWO  
RUSTIC WALNUT • SAP CHERRY • WALNUT • WORMY MAPLE • PLAIN SAWN WHITE OAK • RUSTIC PLAIN SAWN WHITE OAK

## SHAPE OPTIONS



ROUND



OVAL

## EDGE OPTIONS



MISSION  
(STANDARD)



5/8" ROUNDOVER



WATERFALL



BEVEL



CHAMFER



## ALANA SINGLE

shown in Brown  
Maple with FC-48024  
American Antique stain.  
Shown with FN  
Tampa Chairs.

*(Note: Actual color  
may vary from picture)*









# ALANA SINGLE

- 1" Round top with Waterfall edge standard
- Base standard as shown with levelers
- Floor to bottom of skirt 26½"
- Available in 36" height (only on 48" X 48" and 54" X 54" solid top)
- Shown in Brown Maple with FC-48024 American Antique stain  
*(Note: Actual color may vary from picture)*



## SIZES

48" X 48" Round	Up to 2-12" leaves or 1-18" butterfly leaf
54" X 54" Round	Up to 2-12" leaves or 1-18" butterfly leaf
60" X 60" Round	Solid top only

## SPECIES

BROWN MAPLE • RED OAK • QSWO • CHERRY • HARD MAPLE • HICKORY • RUSTIC CHERRY • RUSTIC HICKORY • RUSTIC QSWO  
RUSTIC WALNUT • SAP CHERRY • WALNUT • WORMY MAPLE • PLAIN SAWN WHITE OAK • RUSTIC PLAIN SAWN WHITE OAK

## SHAPE OPTIONS



ROUND

## EDGE OPTIONS



MISSION



5/8" ROUNDOVER



WATERFALL  
(STANDARD)



BEVEL



CHAMFER

# ALBANY SINGLE

- 1" Round top with Ogee edge standard
- Base standard as shown with levelers
- Available in 36" height
- Floor to bottom of skirt 26½"
- 42" round not recommended due to base size



## SIZES

- 48" X 48" Round Up to 2-12" leaves or 1-18" butterfly leaf
- 54" X 54" Round Up to 2-12" leaves or 1-18" butterfly leaf
- 60" X 60" Round Up to 2-12" leaves

## SPECIES

BROWN MAPLE • RED OAK • QSWO • CHERRY • HARD MAPLE • HICKORY • RUSTIC CHERRY • RUSTIC HICKORY • RUSTIC QSWO  
RUSTIC WALNUT • SAP CHERRY • WALNUT • WORMY MAPLE • PLAIN SAWN WHITE OAK • RUSTIC PLAIN SAWN WHITE OAK

## SHAPE OPTIONS



ROUND

## EDGE OPTIONS



MISSION



5/8" ROUNDOVER



WATERFALL



BEVEL



CHAMFER



OGEE  
(STANDARD)

# ARTS & CRAFTS CABINET

- 1" Bow End top with Bevel edge standard
- Standard with 1-18" butterfly leaf
- D925-BL Hardware standard
- Cabinet base is 26½" w x 24" d
- Side mount drawer slides
- 36" high standard. Also available in 30" & 42" h (30" h only has 2 drawers)
- Floor to bottom of skirt 32½"
- Not available with Round top



## SIZES

- |           |  |
|-----------|--|
| 42" X 42" | Solid top, 1-12" leaf, or 1-18" butterfly leaf |
| 42" X 48" | Solid top, 1-12" leaf, or 1-18" butterfly leaf |
| 42" X 54" | Solid top, 1-12" leaf, or 1-18" butterfly leaf |
| 48" X 48" | Solid top, 1-12" leaf, or 1-18" butterfly leaf |
| 48" X 54" | Solid top, 1-12" leaf, or 1-18" butterfly leaf |

## SPECIES

BROWN MAPLE • RED OAK • QSWO • CHERRY • HARD MAPLE • HICKORY • RUSTIC CHERRY • RUSTIC HICKORY • RUSTIC QSWO  
 RUSTIC WALNUT • SAP CHERRY • WALNUT • WORMY MAPLE • PLAIN SAWN WHITE OAK • RUSTIC PLAIN SAWN WHITE OAK

## SHAPE OPTIONS



RECTANGLE



1" RADIUS  
CORNER



BOW END  
(STANDARD)

## EDGE OPTIONS



MISSION



5/8" ROUNDOVER



WATERFALL



BEVEL  
(STANDARD)



CHAMFER



# ARTS & CRAFTS SINGLE

- 1" Round top with Bevel edge standard
- Levelers standard
- Floor to bottom of skirt 26½"
- Shown with optional Lazy Susan



## SIZES

48" X 48" Round	Up to 2-12" leaves or 1-18" butterfly leaf
54" X 54" Round	Up to 2-12" leaves or 1-18" butterfly leaf
60" X 60" Round	Up to 2-12" leaves
72" X 72" Round	Solid top only

## SPECIES

BROWN MAPLE • RED OAK • QSWO • CHERRY • HARD MAPLE • HICKORY • RUSTIC CHERRY • RUSTIC HICKORY • RUSTIC QSWO  
RUSTIC WALNUT • SAP CHERRY • WALNUT • WORMY MAPLE • PLAIN SAWN WHITE OAK • RUSTIC PLAIN SAWN WHITE OAK

## SHAPE OPTIONS



ROUND

## EDGE OPTIONS



MISSION



5/8" ROUNDOVER



WATERFALL



BEVEL  
(STANDARD)



CHAMFER



# ARTS & CRAFTS SINGLE PUB

- 1" Round top with Bevel edge standard
- Levelers standard
- Floor to bottom of skirt 32½"



## SIZES

48" X 48" Round    Up to 2-12" leaves or 1-18" butterfly leaf  
54" X 54" Round    Up to 2-12" leaves or 1-18" butterfly leaf  
60" X 60" Round    Up to 2-12" leaves

## SPECIES

BROWN MAPLE • RED OAK • QSWO • CHERRY • HARD MAPLE • HICKORY • RUSTIC CHERRY • RUSTIC HICKORY • RUSTIC QSWO  
RUSTIC WALNUT • SAP CHERRY • WALNUT • WORMY MAPLE • PLAIN SAWN WHITE OAK • RUSTIC PLAIN SAWN WHITE OAK

## SHAPE OPTIONS



ROUND

## EDGE OPTIONS



MISSION



5/8" ROUNDOVER



WATERFALL



BEVEL  
(STANDARD)



CHAMFER

# ARTS & CRAFTS TRESTLE

- 1" Banquet top with Bevel edge standard
- Trestle base - 26" wide
- Floor to bottom of skirt 26½"
- Available in 36" height



## SIZES

42" X 60"	Up to 4-12" leaves or 1-18" butterfly leaf	Stores up to 4 unskirted leaves
42" X 66"	Up to 4-12" leaves or up to 2-18" butterfly leaves	Stores up to 4 leaves, 2 w/skirts & 2 w/o
42" X 72"	Up to 4-12" leaves or up to 2-18" butterfly leaves	Stores up to 4 leaves, 2 w/skirts & 2 w/o
48" X 60"	Up to 4-12" leaves or 1-18" butterfly leaf	Stores up to 2 leaves, 1 w/skirts & 1 w/o
48" X 66"	Up to 4-12" leaves or up to 2-18" butterfly leaves	Stores up to 4 unskirted leaves
48" X 72"	Up to 4-12" leaves or up to 2-18" butterfly leaves	Stores up to 4 unskirted leaves

Available 84" long, N/A with butterfly leaves. See pricelist for details.

For more than 4 leaves, see page 33

## SPECIES

BROWN MAPLE • RED OAK • QSWO • CHERRY • HARD MAPLE • HICKORY • RUSTIC CHERRY • RUSTIC HICKORY • RUSTIC QSWO  
RUSTIC WALNUT • SAP CHERRY • WALNUT • WORMY MAPLE • PLAIN SAWN WHITE OAK • RUSTIC PLAIN SAWN WHITE OAK

## SHAPE OPTIONS



Changing the top shape may affect self-store ability

## EDGE OPTIONS





# ARTS & CRAFTS BENCH

- 1" Rectangle top with Mission edge
- 18" high
- Leaf storage box to store all 4 leaves
- Solid tops will not have center legs
- Fabric or Leather bench top available – solid top only. See page 32 for details.



## **SIZES**

- |             |                                 |
|-------------|---------------------------------|
| 12 ½" X 48" | Solid top or up to 4-12" leaves |
| 12 ½" X 60" | Solid top or up to 4-12" leaves |
| 12 ½" X 72" | Solid top or up to 4-12" leaves |

## **SPECIES**

BROWN MAPLE • RED OAK • QSWO • CHERRY • HARD MAPLE • HICKORY • RUSTIC CHERRY • RUSTIC HICKORY • RUSTIC QSWO  
RUSTIC WALNUT • SAP CHERRY • WALNUT • WORMY MAPLE • PLAIN SAWN WHITE OAK • RUSTIC PLAIN SAWN WHITE OAK

## **SHAPE OPTIONS**



RECTANGLE

## **EDGE OPTIONS**



MISSION

# AUBURN DOUBLE



- 1" Bow End top with Waterfall edge standard
- Base standard as shown with levelers
- Floor to bottom of skirt 26½"
- Available in 36" height
- Shown in Rustic Hickory with FC-14620 Lite Asbury stain  
(Note: Actual color may vary from picture)



## SIZES

42" X 60"	Up to 4-12" leaves	Stores up to 4 leaves, 2 w/skirts & 2 w/o
42" X 66"	Up to 4-12" leaves	Stores up to 4 leaves, 2 w/skirts & 2 w/o
42" X 72"	Up to 4-12" leaves	Stores up to 4 leaves, 2 w/skirts & 2 w/o
48" X 60"	Up to 4-12" leaves	Stores up to 4 leaves, 2 w/skirts & 2 w/o
48" X 66"	Up to 4-12" leaves	Stores up to 4 leaves, 2 w/skirts & 2 w/o
48" X 72"	Up to 4-12" leaves	Stores up to 4 leaves, 2 w/skirts & 2 w/o

For more than 4 leaves, see page 33

## SPECIES

BROWN MAPLE • RED OAK • QSWO • CHERRY • HARD MAPLE • HICKORY • RUSTIC CHERRY • RUSTIC HICKORY • RUSTIC QSWO  
RUSTIC WALNUT • SAP CHERRY • WALNUT • WORMY MAPLE • PLAIN SAWN WHITE OAK • RUSTIC PLAIN SAWN WHITE OAK

## SHAPE OPTIONS



Changing the top shape may affect self-store ability

## EDGE OPTIONS



# AUBURN SINGLE



- 1" Round with Waterfall edge standard
- Base standard as shown with levelers
- Available in 36" height
- Floor to bottom of skirt 26½"
- Shown in Sap Cherry with FC-40592 Earthtone stain



## SIZES

- 42" X 42" Round Up to 2-12" leaves
- 48" X 48" Round Up to 2-12" leaves or 1-18" butterfly leaf
- 54" X 54" Round Up to 2-12" leaves or 1-18" butterfly leaf

## SPECIES

BROWN MAPLE • RED OAK • QSWO • CHERRY • HARD MAPLE • HICKORY • RUSTIC CHERRY • RUSTIC HICKORY • RUSTIC QSWO  
RUSTIC WALNUT • SAP CHERRY • WALNUT • WORMY MAPLE • PLAIN SAWN WHITE OAK • RUSTIC PLAIN SAWN WHITE OAK

## SHAPE OPTIONS



ROUND

## EDGE OPTIONS



MISSION



5/8" ROUND OVER



WATERFALL  
(STANDARD)



BEVEL



CHAMFER



# AVERY TRESTLE

- 1¼" Semi-Boat top with Bevel edge standard
- Base standard as shown with levelers
- Floor to bottom of skirt 26½"
- Not available in pub height
- Shown in Brown Maple with FC-50240 Carbon top & FC-11047 Ebony base (*Note: Actual color may vary from picture*)



## SIZES

42" X 72" Up to 4-12" leaves Stores up to 4 leaves, 2 w/skirts & 2 w/o  
 48" X 72" Up to 4-12" leaves Stores up to 4 unskirted leaves

Available 84" long, N/A with butterfly leaves. See pricelist for details.

For more than 4 leaves, see page 33

## SPECIES

BROWN MAPLE • RED OAK • QSWO • CHERRY • HARD MAPLE • HICKORY • RUSTIC CHERRY • RUSTIC HICKORY • RUSTIC QSWO  
 RUSTIC WALNUT • SAP CHERRY • WALNUT • WORMY MAPLE • PLAIN SAWN WHITE OAK • RUSTIC PLAIN SAWN WHITE OAK

## SHAPE OPTIONS



RECTANGLE



1" RADIUS  
CORNER



BOW END



SEMI-BOAT  
(STANDARD)

Changing the top shape may affect self-store ability

## EDGE OPTIONS



MISSION



5/8" ROUNDOVER



WATERFALL



BEVEL  
(STANDARD)



CHAMFER



## AVERY TRESTLE

shown in Brown Maple  
with FC-50240 Carbon  
top and FC-11047 Ebony  
base. Shown with FN  
Brookfield Chairs.

*(Note: Actual color  
may vary from picture)*









# BARRINGTON DOUBLE

- 1¼" Rectangle top with 1" radius corner & Mission edge standard
- Base standard as shown with levelers
- Floor to bottom of skirt 26½"
- Not available in pub height



## SIZES

42" X 72"    Up to 4-12" leaves    Stores up to 4 unskirted leaves  
 48" X 72"    Up to 4-12" leaves    Stores up to 4 leaves, 2 w/skirts & 2 w/o  
 Available 84" long, N/A with butterfly leaves. See pricelist for details.

For more than 4 leaves, see page 33

## SPECIES

BROWN MAPLE • RED OAK • QSWO • CHERRY • HARD MAPLE • HICKORY • RUSTIC CHERRY • RUSTIC HICKORY • RUSTIC QSWO  
 RUSTIC WALNUT • SAP CHERRY • WALNUT • WORMY MAPLE • PLAIN SAWN WHITE OAK • RUSTIC PLAIN SAWN WHITE OAK

## SHAPE OPTIONS



RECTANGLE



1" RADIUS  
CORNER (STD)



BOW END



8" SQUARE  
ROUND



BOAT



BANQUET

Changing the top shape may affect self-store ability

## EDGE OPTIONS



MISSION  
(STANDARD)



5/8" ROUNDOVER



WATERFALL



BEVEL



CHAMFER

# BARRINGTON SINGLE

- 1¼" Round top with Mission edge standard
- Base standard as shown with levelers
- Not available in pub height
- 42" Round not recommended due to base size
- Floor to bottom of skirt 26½"



## SIZES

- 48" X 48" Round    Up to 2-12" leaves
- 54" X 54" Round    Up to 2-12" leaves
- 60" X 60" Round    Up to 2-12" leaves

## SPECIES

BROWN MAPLE • RED OAK • QSWO • CHERRY • HARD MAPLE • HICKORY • RUSTIC CHERRY • RUSTIC HICKORY • RUSTIC QSWO  
RUSTIC WALNUT • SAP CHERRY • WALNUT • WORMY MAPLE • PLAIN SAWN WHITE OAK • RUSTIC PLAIN SAWN WHITE OAK

## SHAPE OPTIONS



ROUND

## EDGE OPTIONS



MISSION  
(STANDARD)



5/8" ROUNDOVER



WATERFALL



BEVEL



CHAMFER



# BASSETT CABINET

- 1" top with 6" clip corner and Mission edge standard
- Standard with 1-18" Butterfly leaf
- 1586-ORB hardware standard
- Cabinet base is 25½" w x 23½" d (No options on cabinet size)
- Side mount drawer slides
- 36" high standard. Also available in 30" & 42" h (30" h has no drawer)
- Floor to bottom of skirt 32½"
- Not available with Round top



## SIZES

42" X 42"	Solid top, 1-12" leaf, or 1-18" butterfly leaf
42" X 48"	Solid top, 1-12" leaf, or 1-18" butterfly leaf
42" X 54"	Solid top, 1-12" leaf, or 1-18" butterfly leaf
48" X 48"	Solid top, 1-12" leaf, or 1-18" butterfly leaf
48" X 54"	Solid top, 1-12" leaf, or 1-18" butterfly leaf

## SPECIES

BROWN MAPLE • RED OAK • QSWO • CHERRY • HARD MAPLE • HICKORY • RUSTIC CHERRY • RUSTIC HICKORY • RUSTIC QSWO  
RUSTIC WALNUT • SAP CHERRY • WALNUT • WORMY MAPLE • PLAIN SAWN WHITE OAK • RUSTIC PLAIN SAWN WHITE OAK

## SHAPE OPTIONS



RECTANGLE



1" RADIUS  
CORNER



BOW END



6" CLIPPED  
CORNERS  
(STANDARD)

## EDGE OPTIONS



MISSION  
(STANDARD)



5/8" ROUNDOVER



WATERFALL



BEVEL



CHAMFER



# BAYTOWN DOUBLE

- 1" Bow End top with Waterfall edge standard
- Available in 36" height
- Base standard as shown with levelers
- Floor to bottom of skirt 26½"



## SIZES

42" X 60"	Up to 4-12" leaves	Stores up to 4 leaves, 2 w/skirts & 2 w/o
42" X 66"	Up to 4-12" leaves	Stores up to 4 leaves, 2 w/skirts & 2 w/o
42" X 72"	Up to 4-12" leaves	Stores up to 4 leaves, 2 w/skirts & 2 w/o
48" X 60"	Up to 4-12" leaves	Stores up to 4 leaves, 2 w/skirts & 2 w/o
48" X 66"	Up to 4-12" leaves	Stores up to 4 leaves, 2 w/skirts & 2 w/o
48" X 72"	Up to 4-12" leaves	Stores up to 4 leaves, 2 w/skirts & 2 w/o

For more than 4 leaves, see page 33

## SPECIES

BROWN MAPLE • RED OAK • QSWO • CHERRY • HARD MAPLE • HICKORY • RUSTIC CHERRY • RUSTIC HICKORY • RUSTIC QSWO  
RUSTIC WALNUT • SAP CHERRY • WALNUT • WORMY MAPLE • PLAIN SAWN WHITE OAK • RUSTIC PLAIN SAWN WHITE OAK

## SHAPE OPTIONS



Changing the top shape may affect self-store ability

## EDGE OPTIONS



## BAYTOWN DOUBLE

shown in Brown Maple  
with FC-42000 Almond  
stain. Shown with  
Artisan Curry Chairs.

*(Note: Actual color  
may vary from picture)*









## BAYTOWN SINGLE

shown in Brown Maple  
with D22N08963  
Sandstone stain.  
Shown with FN  
Maverick Chairs.

*(Note: Actual color  
may vary from picture)*







# BAYTOWN SINGLE



42" X 42" 30" high  
2-12" leaves  
Brown Maple  
Standard shape & edge

- 1" Round top with Waterfall edge standard
- Also available in oval top
- Base standard as shown with levelers
- Floor to bottom of skirt 26½"
- Available in 36" height



## SIZES

42" X 42" Round	Up to 2-12" Leaves	
48" X 48" Round	Up to 2-12" Leaves, or 1-18" Butterfly Leaf	
54" X 54" Round	Up to 2-12" Leaves, or 1-18" Butterfly Leaf	
36" X 48" Oval	Up to 2-12" Leaves	Stores up to 2 unskirted leaves
42" X 54" Oval	Up to 2-12" Leaves	Stores up to 2 leaves, 1 w/skirt & 1 w/o

## SPECIES

BROWN MAPLE • RED OAK • QSWO • CHERRY • HARD MAPLE • HICKORY • RUSTIC CHERRY • RUSTIC HICKORY • RUSTIC QSWO  
RUSTIC WALNUT • SAP CHERRY • WALNUT • WORMY MAPLE • PLAIN SAWN WHITE OAK • RUSTIC PLAIN SAWN WHITE OAK

## SHAPE OPTIONS



ROUND



OVAL

## EDGE OPTIONS



MISSION



5/8" ROUNDOVER



WATERFALL  
(STANDARD)



BEVEL



CHAMFER



# BENNINGTON LEG



- 1¼" Rectangle top with 4" radius corners and Underbevel edge standard
- Legs standard as shown
- Floor to bottom of skirt 26½" on sides and 23¼" on ends
- Not available in pub height
- Shown in Sap Cherry with FC-42000 Almond 10 sheen finish  
*(Note: Actual color may vary from picture)*



## SIZES

36" X 60"	Solid top only
36" X 72"	Solid top only
36" X 84"	Solid top only
42" X 60"	Solid top only
42" X 72"	Solid top only
42" X 84"	Solid top only

## SPECIES

BROWN MAPLE • RED OAK • QSWO • CHERRY • HARD MAPLE • HICKORY • RUSTIC CHERRY • RUSTIC HICKORY • RUSTIC QSWO  
RUSTIC WALNUT • SAP CHERRY • WALNUT • WORMY MAPLE • PLAIN SAWN WHITE OAK • RUSTIC PLAIN SAWN WHITE OAK

## SHAPE OPTIONS



4" RADIUS  
CORNER

## EDGE OPTIONS



UNDERBEVEL



## BERKSHIRE LEG

shown in Brown Maple  
with Coffee stain.  
Shown with Artisan  
Berkshire Reeded  
Leg Chairs.

*(Note: Actual color  
may vary from picture)*









# BERKSHIRE LEG

- 1¼" thick smooth with 1" corner radius top & Mission edge standard
- 4½" leg standard as shown, optional reeded leg
- 3½" straight skirt
- Floor to bottom of skirt 25½"
- Available in 36" height
- Recommended chair: Berkshire from Artisan Chairs



## SIZES

42" X 60"	Up to 4-12" leaves	Stores up to 4 leaves, 2 w/skirts & 2 w/o
42" X 66"	Up to 4-12" leaves	Stores up to 4 leaves, 2 w/skirts & 2 w/o
42" X 72"	Up to 4-12" leaves	Stores up to 4 leaves, 2 w/skirts & 2 w/o
48" X 60"	Up to 4-12" leaves	Stores up to 4 leaves, 2 w/skirts & 2 w/o
48" X 66"	Up to 4-12" leaves	Stores up to 4 leaves, 2 w/skirts & 2 w/o
48" X 72"	Up to 4-12" leaves	Stores up to 4 leaves, 2 w/skirts & 2 w/o

Available 84" long, N/A with butterfly leaves. See pricelist for details.

For more than 4 leaves, see page 33

## SPECIES

BROWN MAPLE • RED OAK • QSWO • CHERRY • HARD MAPLE • HICKORY • RUSTIC CHERRY • RUSTIC HICKORY • RUSTIC QSWO  
RUSTIC WALNUT • SAP CHERRY • WALNUT • WORMY MAPLE • PLAIN SAWN WHITE OAK • RUSTIC PLAIN SAWN WHITE OAK

## SHAPE OPTIONS



RECTANGLE



1" RADIUS  
CORNER (STD)



BOW END

## EDGE OPTIONS



MISSION  
(STANDARD)



5/8" ROUND OVER



WATERFALL



BEVEL



CHAMFER

# BRADEN TRESTLE

- 1" Rectangle top with 1" radius corners and Waterfall edge standard
- Base standard as shown with levelers
- Floor to bottom of skirt 26½"
- Available in 36" height
- Shown in Brown Maple with FC-42000 Almond top & PCL-183 Muted White 10 sheen base  
*(Note: Actual color may vary from picture)*



## SIZES

36" X 48"	Up to 3-12" leaves	Stores up to 2 unskirted leaves
36" X 54"	Up to 3-12" leaves	Stores up to 2 unskirted leaves
36" X 60"	Up to 3-12" leaves	Stores up to 2 unskirted leaves
42" X 48"	Up to 3-12" leaves	Self-store NOT available
42" X 54"	Up to 3-12" leaves	Stores up to 3 unskirted leaves
42" X 60"	Up to 3-12" leaves	Stores up to 3 unskirted leaves

## SPECIES

BROWN MAPLE • RED OAK • QSWO • CHERRY • HARD MAPLE • HICKORY • RUSTIC CHERRY • RUSTIC HICKORY • RUSTIC QSWO  
RUSTIC WALNUT • SAP CHERRY • WALNUT • WORMY MAPLE • PLAIN SAWN WHITE OAK • RUSTIC PLAIN SAWN WHITE OAK

## SHAPE OPTIONS



RECTANGLE



1" RADIUS  
CORNER (STD)



BOW END

## EDGE OPTIONS



MISSION



5/8" ROUNDOVER



WATERFALL  
(STANDARD)



BEVEL



CHAMFER



# BRADEN BENCH

- 1" Rectangle top with Mission edge standard
- 18" high
- Leaf storage box to store all 3 leaves
- Solid tops will not have center legs
- Fabric or Leather bench top available – solid top only. See page 32 for details.
- Shown in Brown Maple with FC-42000 Almond top & PCL-183 Muted White 10 sheen base  
(Note: Actual color may vary from picture)



## SIZES

12 ½" X 48"	Solid top or up to 3-12" leaves
12 ½" X 54"	Solid top or up to 3-12" leaves
12 ½" X 60"	Solid top or up to 3-12" leaves

## SPECIES

BROWN MAPLE • RED OAK • QSWO • CHERRY • HARD MAPLE • HICKORY • RUSTIC CHERRY • RUSTIC HICKORY • RUSTIC QSWO  
RUSTIC WALNUT • SAP CHERRY • WALNUT • WORMY MAPLE • PLAIN SAWN WHITE OAK • RUSTIC PLAIN SAWN WHITE OAK

## SHAPE OPTIONS



RECTANGLE

## EDGE OPTIONS



MISSION



# BRADY LEG

- 1" Round top with Mission edge standard
- Legs standard as shown (no options)
- Floor to bottom of skirt 26½"
- Not available in pub height



## SIZES

- 42" X 42" Round Up to 2-12" leaves
- 48" X 48" Round Up to 2-12" leaves
- 54" X 54" Round Up to 2-12" leaves

## SPECIES

BROWN MAPLE • RED OAK • QSWO • CHERRY • HARD MAPLE • HICKORY • RUSTIC CHERRY • RUSTIC HICKORY • RUSTIC QSWO  
RUSTIC WALNUT • SAP CHERRY • WALNUT • WORMY MAPLE • PLAIN SAWN WHITE OAK • RUSTIC PLAIN SAWN WHITE OAK

## SHAPE OPTIONS



ROUND

## EDGE OPTIONS



MISSION  
(STANDARD)



5/8" ROUNDOVER



WATERFALL



BEVEL



CHAMFER



# BRIDGEPORT TRESTLE

- 1" Rectangle top with Reverse Chamfer edge standard
- 3" skirt with Chamfer edge on bottom of skirt
- No gap cover (not available)
- Base standard as shown with levelers
- Floor to bottom of skirt 26"
- Not available in pub height



## SIZES

42" X 60"	Up to 4-12" leaves	Stores up to 4 unskirted leaves
42" X 66"	Up to 4-12" leaves	Stores up to 4 leaves, 2 w/skirts & 2 w/o
42" X 72"	Up to 4-12" leaves	Stores up to 4 leaves, 2 w/skirts & 2 w/o
48" X 60"	Up to 4-12" leaves	Stores up to 4 leaves, 2 w/skirts & 2 w/o
48" X 66"	Up to 4-12" leaves	Stores up to 4 unskirted leaves
48" X 72"	Up to 4-12" leaves	Stores up to 4 unskirted leaves

Available 84" long, N/A with butterfly leaves. See pricelist for details.

For more than 4 leaves, see page 33

## SPECIES

BROWN MAPLE • RED OAK • QSWO • CHERRY • HARD MAPLE • HICKORY • RUSTIC CHERRY • RUSTIC HICKORY • RUSTIC QSWO  
RUSTIC WALNUT • SAP CHERRY • WALNUT • WORMY MAPLE • PLAIN SAWN WHITE OAK • RUSTIC PLAIN SAWN WHITE OAK

## SHAPE OPTIONS



RECTANGLE

## EDGE OPTIONS



REVERSE CHAMFER



## BRIDGEPORT TRESTLE

shown in Brown Maple with  
FC-40592 Earthtone stain. Shown  
with Artisan Gatlinburg Chairs.

*(Note: Actual color may vary from picture)*





# BRIDGEPORT BENCH

- 1" Rectangle top with Mission edge standard
- 18" high
- Leaf storage box to store all 4 leaves
- Solid tops will not have center legs
- Fabric or Leather bench top available – solid top only. See page 32 for details.



## **SIZES**

- |             |                                 |
|-------------|---------------------------------|
| 12 ½" X 48" | Solid top or up to 4-12" leaves |
| 12 ½" X 60" | Solid top or up to 4-12" leaves |
| 12 ½" X 72" | Solid top or up to 4-12" leaves |

## **SPECIES**

BROWN MAPLE • RED OAK • QSWO • CHERRY • HARD MAPLE • HICKORY • RUSTIC CHERRY • RUSTIC HICKORY • RUSTIC QSWO  
RUSTIC WALNUT • SAP CHERRY • WALNUT • WORMY MAPLE • PLAIN SAWN WHITE OAK • RUSTIC PLAIN SAWN WHITE OAK

## **SHAPE OPTIONS**



RECTANGLE

## **EDGE OPTIONS**



MISSION

# BRINKLEY TRESTLE

- 1" Rectangle top with Bevel edge standard
- Base standard as shown with levelers
- Floor to bottom of skirt 26½"
- Not available in pub height
- Shown in Brown Maple with FC-42000 Almond stain  
*(Note: Actual color may vary from picture)*



## SIZES

42" X 60"	Up to 4-12" leaves or 1-18" butterfly leaf	Stores up to 4 unskirted leaves
42" X 66"	Up to 4-12" leaves or up to 2-18" butterfly leaves	Stores up to 4 leaves, 2 w/skirts & 2 w/o
42" X 72"	Up to 4-12" leaves or up to 2-18" butterfly leaves	Stores up to 4 leaves, 2 w/skirts & 2 w/o
48" X 60"	Up to 4-12" leaves or 1-18" butterfly leaf	Stores up to 4 leaves, 2 w/skirts & 2 w/o
48" X 66"	Up to 4-12" leaves or up to 2-18" butterfly leaves	Stores up to 4 unskirted leaves
48" X 72"	Up to 4-12" leaves or up to 2-18" butterfly leaves	Stores up to 4 unskirted leaves

*Available 84" long, N/A with butterfly leaves. See pricelist for details.*

*For more than 4 leaves, see page 33*

## SPECIES

BROWN MAPLE • RED OAK • QSWO • CHERRY • HARD MAPLE • HICKORY • RUSTIC CHERRY • RUSTIC HICKORY • RUSTIC QSWO  
RUSTIC WALNUT • SAP CHERRY • WALNUT • WORMY MAPLE • PLAIN SAWN WHITE OAK • RUSTIC PLAIN SAWN WHITE OAK

## SHAPE OPTIONS



*Changing the top shape may affect self-store ability*

## EDGE OPTIONS



## BRINKLEY TRESTLE

shown in Brown Maple  
with FC-42000 Almond  
stain. Shown with FN  
Sophia Chairs.

*(Note: Actual color  
may vary from picture)*







# BROADWAY LEG

- 1" Bow End top with Mission edge standard
- 3½" skirt standard as shown
- Curved legs standard as shown
- Available in 36" height
- Floor to bottom of skirt is 25½" at the legs and 26½" at the center
- Shown in Brown Maple with Asbury Brown stain  
(Note: Actual color may vary from picture)



## SIZES

42" X 60"	Up to 4-12" leaves or 1-18" butterfly leaf	Stores up to 4 leaves, 2 w/skirts & 2 w/o
42" X 66"	Up to 4-12" leaves or 1-18" butterfly leaf	Stores up to 4 leaves, 2 w/skirts & 2 w/o
42" X 72"	Up to 4-12" leaves or 1-18" butterfly leaf	Stores up to 4 leaves, 2 w/skirts & 2 w/o
48" X 60"	Up to 4-12" leaves or 1-18" butterfly leaf	Stores up to 4 leaves, 2 w/skirts & 2 w/o
48" X 66"	Up to 4-12" leaves or 1-18" butterfly leaf	Stores up to 4 leaves, 2 w/skirts & 2 w/o
48" X 72"	Up to 4-12" leaves or 1-18" butterfly leaf	Stores up to 4 leaves, 2 w/skirts & 2 w/o

Available 84" long, N/A with butterfly leaves. See pricelist for details.

For more than 4 leaves, see page 33

## SPECIES

BROWN MAPLE • RED OAK • QSWO • CHERRY • HARD MAPLE • HICKORY • RUSTIC CHERRY • RUSTIC HICKORY • RUSTIC QSWO  
RUSTIC WALNUT • SAP CHERRY • WALNUT • WORMY MAPLE • PLAIN SAWN WHITE OAK • RUSTIC PLAIN SAWN WHITE OAK

## SHAPE OPTIONS



RECTANGLE



1" RADIUS  
CORNER



BOW END  
(STANDARD)



8" SQUARE  
ROUND



BOAT



BANQUET

## EDGE OPTIONS



MISSION  
(STANDARD)



5/8" ROUNDOVER



WATERFALL



BEVEL



CHAMFER

# BROADWAY BENCH

- 1" Bow End top with Mission edge
- 18" high
- Leaf storage box to store all 4 leaves
- Solid tops will not have center legs
- Fabric or Leather bench top available – solid top only. See page 32 for details.



## SIZES

12 ½" X 48"	Solid top or up to 4-12" leaves
12 ½" X 60"	Solid top or up to 4-12" leaves
12 ½" X 72"	Solid top or up to 4-12" leaves

## SPECIES

BROWN MAPLE • RED OAK • QSWO • CHERRY • HARD MAPLE • HICKORY • RUSTIC CHERRY • RUSTIC HICKORY • RUSTIC QSWO  
RUSTIC WALNUT • SAP CHERRY • WALNUT • WORMY MAPLE • PLAIN SAWN WHITE OAK • RUSTIC PLAIN SAWN WHITE OAK

## SHAPE OPTIONS



BOW END

## EDGE OPTIONS



MISSION



# BROOKLYN SINGLE

- 1¼" Round top with Mission edge standard
- Black powder coated metal base with levelers
- Floor to bottom of skirt 26½"
- Not available in pub height
- Shown in Rustic Walnut with Natural Finish  
*(Note: Actual color may vary from picture)*



## SIZES

42" X 42" Round	Up to 2-12" leaves
48" X 48" Round	Up to 2-12" leaves
54" X 54" Round	Up to 2-12" leaves

## SPECIES

BROWN MAPLE • RED OAK • QSWO • CHERRY • HARD MAPLE • HICKORY • RUSTIC CHERRY • RUSTIC HICKORY • RUSTIC QSWO  
RUSTIC WALNUT • SAP CHERRY • WALNUT • WORMY MAPLE • PLAIN SAWN WHITE OAK • RUSTIC PLAIN SAWN WHITE OAK

## SHAPE OPTIONS



ROUND

## EDGE OPTIONS



MISSION  
(STANDARD)



5/8" ROUNDOVER



WATERFALL



BEVEL



CHAMFER

# BROOKVILLE SINGLE

- 1" Round top with Bevel edge standard
- Base standard as shown with levelers
- Floor to bottom of skirt 26½"
- Recommended chair: Brookville from Artisan Chairs
- Shown in 30" height



## SIZES

48" X 48" Round	Up to 2-12" leaves or 1-18" butterfly leaf
54" X 54" Round	Up to 2-12" leaves or 1-18" butterfly leaf
60" X 60" Round	Up to 2-12" leaves
72" X 72" Round	Solid top only

## SPECIES

BROWN MAPLE • RED OAK • QSWO • CHERRY • HARD MAPLE • HICKORY • RUSTIC CHERRY • RUSTIC HICKORY • RUSTIC QSWO  
RUSTIC WALNUT • SAP CHERRY • WALNUT • WORMY MAPLE • PLAIN SAWN WHITE OAK • RUSTIC PLAIN SAWN WHITE OAK

## SHAPE OPTIONS



ROUND

## EDGE OPTIONS



MISSION



5/8" ROUNDOVER



WATERFALL



BEVEL  
(STANDARD)



CHAMFER



# BROOKVILLE SINGLE PUB

- 1" Round top with Bevel edge standard
- Base standard as shown with levelers
- Floor to bottom of skirt 32½"
- Shown in 36" height



## SIZES

- 48" X 48" Round Up to 2-12" leaves or 1-18" butterfly leaf
- 54" X 54" Round Up to 2-12" leaves or 1-18" butterfly leaf
- 60" X 60" Round Up to 2-12" leaves

## SPECIES

BROWN MAPLE • RED OAK • QSWO • CHERRY • HARD MAPLE • HICKORY • RUSTIC CHERRY • RUSTIC HICKORY • RUSTIC QSWO  
RUSTIC WALNUT • SAP CHERRY • WALNUT • WORMY MAPLE • PLAIN SAWN WHITE OAK • RUSTIC PLAIN SAWN WHITE OAK

## SHAPE OPTIONS



ROUND

## EDGE OPTIONS



MISSION



5/8" ROUNDOVER



WATERFALL



BEVEL  
(STANDARD)



CHAMFER



# BURLINGTON DOUBLE



- 1¼" Bow End top with Waterfall edge standard
- Base standard as shown with levelers
- Floor to bottom of skirt 26½"
- Leaf table will have grain side-to-side
- Solid top will have grain lengthwise
- Shown in Brown Maple with Asbury Brown stain, 48" X 108"  
*(Note: Actual color may vary from picture)*



## SIZES

42" X 96"	Up to 4-12" leaves	Stores up to 2 unskirted leaves
42" X 108"	Solid top only	
42" X 120"	Solid top only	
48" X 96"	Up to 4-12" leaves	Stores up to 2 unskirted leaves
48" X 108"	Solid top only	
48" X 120"	Solid top only	

## SPECIES

BROWN MAPLE • RED OAK • QSWO • CHERRY • HARD MAPLE • HICKORY • RUSTIC CHERRY • RUSTIC HICKORY • RUSTIC QSWO  
RUSTIC WALNUT • SAP CHERRY • WALNUT • WORMY MAPLE • PLAIN SAWN WHITE OAK • RUSTIC PLAIN SAWN WHITE OAK

## SHAPE OPTIONS



RECTANGLE



1" RADIUS  
CORNER



BOW END  
(STANDARD)

## EDGE OPTIONS



MISSION



5/8" ROUNDOVER



WATERFALL  
(STANDARD)



BEVEL



CHAMFER



## BURLINGTON DOUBLE

shown in Brown Maple  
with FC-7992 Asbury  
Brown stain, 48" X 108".

Shown with FN  
Ramsey Chairs.

*(Note: Actual color  
may vary from picture)*









# BURLINGTON SINGLE



60" X 60" 30" high  
Solid Top  
Brown Maple or  
Rustic Cherry  
Standard shape & edge

- 1¼" Round top with Waterfall edge standard
- 13" pedestal standard with 48" & 54" top, 15" pedestal standard with 60" & 72" top
- Base standard as shown with levelers
- 42" round not available due to base size
- Floor to bottom of skirt 26½"
- Available in 36" height
- Recommended chair: Ramsey from FN Chairs
- Shown in Brown Maple with Asbury Brown stain  
*(Note: Actual color may vary from picture)*



## SIZES

48" X 48" Round	Up to 2-12" leaves
54" X 54" Round	Up to 2-12" leaves
60" X 60" Round	Up to 2-12" leaves
72" X 72" Round	Solid top only

## SPECIES

BROWN MAPLE • RED OAK • QSWO • CHERRY • HARD MAPLE • HICKORY • RUSTIC CHERRY • RUSTIC HICKORY • RUSTIC QSWO  
RUSTIC WALNUT • SAP CHERRY • WALNUT • WORMY MAPLE • PLAIN SAWN WHITE OAK • RUSTIC PLAIN SAWN WHITE OAK

## SHAPE OPTIONS



ROUND

## EDGE OPTIONS



MISSION



5/8" ROUND OVER



WATERFALL  
(STANDARD)



BEVEL



CHAMFER



## BURLINGTON SINGLE

shown in Brown Maple with  
FC-42000 Almond stain.

Shown with Artisan Bailey Chairs.

*(Note: Actual color may vary from picture)*



# CAMBRIDGE TRESTLE

- 1" Rectangle top with Mission edge standard
- Not available in pub height
- Base standard as shown with levelers
- Floor to bottom of skirt 26½"



## SIZES

42" X 60"	Up to 4-12" leaves or 1-18" butterfly leaf	Stores up to 4 unskirted leaves
42" X 66"	Up to 4-12" leaves or up to 2-18" butterfly leaves	Stores up to 4 leaves, 2 w/skirts & 2 w/o
42" X 72"	Up to 4-12" leaves or up to 2-18" butterfly leaves	Stores up to 4 leaves, 2 w/skirts & 2 w/o
48" X 60"	Up to 4-12" leaves or 1-18" butterfly leaf	Stores up to 4 leaves, 2 w/skirts & 2 w/o
48" X 66"	Up to 4-12" leaves or up to 2-18" butterfly leaves	Stores up to 4 unskirted leaves
48" X 72"	Up to 4-12" leaves or up to 2-18" butterfly leaves	Stores up to 4 unskirted leaves

Available 84" long, N/A with butterfly leaves. See pricelist for details.

For more than 4 leaves, see page 33

## SPECIES

BROWN MAPLE • RED OAK • QSWO • CHERRY • HARD MAPLE • HICKORY • RUSTIC CHERRY • RUSTIC HICKORY • RUSTIC QSWO  
RUSTIC WALNUT • SAP CHERRY • WALNUT • WORMY MAPLE • PLAIN SAWN WHITE OAK • RUSTIC PLAIN SAWN WHITE OAK

## SHAPE OPTIONS



Changing the top shape may affect self-store ability

## EDGE OPTIONS





# CAMBRIDGE BENCH

- 1" Rectangle top with Mission edge
- 18" high
- Leaf storage box to store all 4 leaves
- Solid tops will not have center legs
- Fabric or Leather bench top available – solid top only. See page 32 for details.



## SIZES

- |             |                                 |
|-------------|---------------------------------|
| 12 ½" X 48" | Solid top or up to 4-12" leaves |
| 12 ½" X 60" | Solid top or up to 4-12" leaves |
| 12 ½" X 72" | Solid top or up to 4-12" leaves |

## SPECIES

BROWN MAPLE • RED OAK • QSWO • CHERRY • HARD MAPLE • HICKORY • RUSTIC CHERRY • RUSTIC HICKORY • RUSTIC QSWO  
RUSTIC WALNUT • SAP CHERRY • WALNUT • WORMY MAPLE • PLAIN SAWN WHITE OAK • RUSTIC PLAIN SAWN WHITE OAK

## SHAPE OPTIONS



RECTANGLE

## EDGE OPTIONS



MISSION



## CANTERBURY LEG

shown in Grey Elm with Michael's Cherry stain and Brown Maple base with Onyx stain. Shown with Artisan Canterbury Chairs.

*(Note: Actual color may vary from picture)*









# CANTERBURY LEG

- 1" Canterbury top with Waterfall edge standard
- 3½" arched skirt
- Legs standard as shown
- Available in 36" height
- Floor to bottom of skirt is 25½" at the legs and 26½" at the center
- Recommended chair: Canterbury from Artisan Chairs



## SIZES

42" X 60"	Up to 4-12" leaves or 1-18" butterfly leaf	Stores up to 4 leaves, 2 w/skirts & 2 w/o
42" X 66"	Up to 4-12" leaves or 1-18" butterfly leaf	Stores up to 4 leaves, 2 w/skirts & 2 w/o
42" X 72"	Up to 4-12" leaves or 1-18" butterfly leaf	Stores up to 4 leaves, 2 w/skirts & 2 w/o
48" X 60"	Up to 4-12" leaves or 1-18" butterfly leaf	Stores up to 4 leaves, 2 w/skirts & 2 w/o
48" X 66"	Up to 4-12" leaves or 1-18" butterfly leaf	Stores up to 4 leaves, 2 w/skirts & 2 w/o
48" X 72"	Up to 4-12" leaves or 1-18" butterfly leaf	Stores up to 4 leaves, 2 w/skirts & 2 w/o

Available 84" long, N/A with butterfly leaves. See pricelist for details.

For more than 4 leaves, see page 33

## SPECIES

BROWN MAPLE • RED OAK • QSWO • CHERRY • HARD MAPLE • HICKORY • RUSTIC CHERRY • RUSTIC HICKORY • RUSTIC QSWO  
RUSTIC WALNUT • SAP CHERRY • WALNUT • WORMY MAPLE • PLAIN SAWN WHITE OAK • RUSTIC PLAIN SAWN WHITE OAK

## SHAPE OPTIONS



RECTANGLE



1" RADIUS  
CORNER



CANTERBURY  
(STANDARD)

## EDGE OPTIONS



MISSION



5/8" ROUNDOVER



WATERFALL  
(STANDARD)



BEVEL



CHAMFER

# CANTERBURY BENCH

- 1" Bow End top with Waterfall edge standard
- 18" high
- Leaf storage box to store all 4 leaves
- Solid tops will not have center legs
- Fabric or Leather bench top available – solid top only. See page 32 for details.
- Shown in Brown Maple with FC - 9018 Lite Asbury top & FC - 230 Onyx base  
*(Note: Actual color may vary from picture)*



## **SIZES**

- 12 ½" X 48" Solid top or up to 4-12" leaves
- 12 ½" X 60" Solid top or up to 4-12" leaves
- 12 ½" X 72" Solid top or up to 4-12" leaves

## **SPECIES**

BROWN MAPLE • RED OAK • QSWO • CHERRY • HARD MAPLE • HICKORY • RUSTIC CHERRY • RUSTIC HICKORY • RUSTIC QSWO  
RUSTIC WALNUT • SAP CHERRY • WALNUT • WORMY MAPLE • PLAIN SAWN WHITE OAK • RUSTIC PLAIN SAWN WHITE OAK

## **SHAPE OPTIONS**



BOW END

## **EDGE OPTIONS**



WATERFALL



# CARSON SINGLE

- 1" Round top with Mission edge standard
- Base standard as shown with levelers
- Floor to bottom of skirt 26½"
- Available in 36" height
- Shown in Brown Maple with Med-Dis. FC-14620 Lite Asbury finish  
*(Note: Actual color may vary from picture)*



## SIZES

- 48" X 48" Round    Up to 2-12" leaves or 1-18" butterfly leaf  
54" X 54" Round    Up to 2-12" leaves or 1-18" butterfly leaf

## SPECIES

BROWN MAPLE • RED OAK • QSWO • CHERRY • HARD MAPLE • HICKORY • RUSTIC CHERRY • RUSTIC HICKORY • RUSTIC QSWO  
RUSTIC WALNUT • SAP CHERRY • WALNUT • WORMY MAPLE • PLAIN SAWN WHITE OAK • RUSTIC PLAIN SAWN WHITE OAK

## SHAPE OPTIONS



ROUND

## EDGE OPTIONS



MISSION  
(STANDARD)



5/8" ROUND OVER



WATERFALL



BEVEL



CHAMFER



# CENTURY CABINET



- 1" top with 1" radius corners with Waterfall edge standard
- Base standard as shown with levelers
- 36781-CZ Hardware standard
- Cabinet base is 25" w x 25" d (no options)
- Side mount drawer slides
- 36" high standard. Also available in 30" & 42" h (30" h only has 2 drawers)
- Floor to bottom of skirt 32½"
- Not available with Round top
- Shown in Rustic Walnut with Natural finish  
*(Note: Actual color may vary from picture)*



## SIZES

- 42" X 42" Solid top, 1-12" leaf, or 1-18" butterfly leaf
- 42" X 48" Solid top, 1-12" leaf, or 1-18" butterfly leaf
- 42" X 54" Solid top, 1-12" leaf, or 1-18" butterfly leaf
- 48" X 48" Solid top, 1-12" leaf, or 1-18" butterfly leaf
- 48" X 54" Solid top, 1-12" leaf, or 1-18" butterfly leaf

## SPECIES

BROWN MAPLE • RED OAK • QSWO • CHERRY • HARD MAPLE • HICKORY • RUSTIC CHERRY • RUSTIC HICKORY • RUSTIC QSWO  
RUSTIC WALNUT • SAP CHERRY • WALNUT • WORMY MAPLE • PLAIN SAWN WHITE OAK • RUSTIC PLAIN SAWN WHITE OAK

## SHAPE OPTIONS



RECTANGLE



1" RADIUS  
CORNER  
(STANDARD)



BOW END

## EDGE OPTIONS



MISSION



5/8" ROUNDOVER



WATERFALL  
(STANDARD)



BEVEL



CHAMFER



## CHANCELLOR DOUBLE

shown in Brown  
Maple with FC-40592  
Earhtone stain.  
Shown with Artisan  
Albany Chairs.

*(Note: Actual color  
may vary from picture)*









# CHANCELLOR DOUBLE

- 1" Banquet top with Bevel edge standard
- Base standard as shown with levelers
- Pedestals do not move apart as top opens
- Floor to bottom of skirt 26½"
- Available in 36" height



## SIZES

42" X 72" Up to 4-12" leaves  
 48" X 72" Up to 4-12" leaves

Stores up to 4 leaves, 2 w/skirts & 2 w/o  
 Stores up to 4 leaves, 2 w/skirts & 2 w/o

*For more than 4 leaves, see page 33*

## SPECIES

BROWN MAPLE • RED OAK • QSWO • CHERRY • HARD MAPLE • HICKORY • RUSTIC CHERRY • RUSTIC HICKORY • RUSTIC QSWO  
 RUSTIC WALNUT • SAP CHERRY • WALNUT • WORMY MAPLE • PLAIN SAWN WHITE OAK • RUSTIC PLAIN SAWN WHITE OAK

## SHAPE OPTIONS



RECTANGLE



1" RADIUS  
CORNER



BOW END



8" SQUARE  
ROUND



BANQUET  
(STANDARD)

*Changing the top shape may affect self-store ability*

## EDGE OPTIONS



MISSION



5/8" ROUNDOVER



WATERFALL



BEVEL  
(STANDARD)



CHAMFER

# CHANCELLOR SINGLE

- 1" Round top with Bevel edge standard
- Base standard as shown with levelers
- Floor to bottom of skirt 26½"
- Available in 36" height



## SIZES

- 42" X 42" Round Up to 2-12" leaves
- 48" X 48" Round Up to 2-12" leaves or 1-18" butterfly leaf
- 54" X 54" Round Up to 2-12" leaves or 1-18" butterfly leaf

## SPECIES

BROWN MAPLE • RED OAK • QSWO • CHERRY • HARD MAPLE • HICKORY • RUSTIC CHERRY • RUSTIC HICKORY • RUSTIC QSWO  
RUSTIC WALNUT • SAP CHERRY • WALNUT • WORMY MAPLE • PLAIN SAWN WHITE OAK • RUSTIC PLAIN SAWN WHITE OAK

## SHAPE OPTIONS



ROUND

## EDGE OPTIONS



MISSION



5/8" ROUND OVER



WATERFALL



BEVEL  
(STANDARD)



CHAMFER



# CHESAPEAKE TRESTLE

- 1" Rectangle top with Mission edge standard
- Base standard as shown (with levelers)
- Floor to bottom of skirt 26½"
- Not available in pub height
- Shown in Brown Maple with FC-40592 Earthtone top & FP-5155 Country White base  
(Note: Actual color may vary from picture)



## SIZES

42" X 60"	Up to 4-12" leaves	Stores up to 4 unskirted leaves
42" X 66"	Up to 4-12" leaves	Stores up to 4 leaves, 2 w/skirts & 2 w/o
42" X 72"	Up to 4-12" leaves	Stores up to 4 leaves, 2 w/skirts & 2 w/o
48" X 60"	Up to 4-12" leaves	Stores up to 4 leaves, 2 w/skirts & 2 w/o
48" X 66"	Up to 4-12" leaves	Stores up to 4 unskirted leaves
48" X 72"	Up to 4-12" leaves	Stores up to 4 unskirted leaves

Available 84" long, N/A with butterfly leaves. See pricelist for details.

For more than 4 leaves, see page 33

## SPECIES

BROWN MAPLE • RED OAK • QSWO • CHERRY • HARD MAPLE • HICKORY • RUSTIC CHERRY • RUSTIC HICKORY • RUSTIC QSWO  
RUSTIC WALNUT • SAP CHERRY • WALNUT • WORMY MAPLE • PLAIN SAWN WHITE OAK • RUSTIC PLAIN SAWN WHITE OAK

## SHAPE OPTIONS



RECTANGLE  
(STANDARD)



1" RADIUS  
CORNER



BOW END



8" SQUARE  
ROUND



BOAT



BANQUET

Changing the top shape may affect self-store ability

## EDGE OPTIONS



MISSION  
(STANDARD)



5/8" ROUND  
OVER



WATERFALL



BEVEL



CHAMFER



# CHESAPEAKE BENCH

- 1" Rectangle top with Mission edge standard
- 18" high
- Leaf storage box to store all 4 leaves
- Solid tops will not have center legs
- Fabric or Leather bench top available – solid top only. See page 32 for details.
- Shown in Brown Maple with FC-40592 Earthtone top & FP-5155 Country White base  
(Note: Actual color may vary from picture)



## SIZES

12 ½" X 48"	Solid top or up to 4-12" leaves
12 ½" X 60"	Solid top or up to 4-12" leaves
12 ½" X 72"	Solid top or up to 4-12" leaves

## SPECIES

BROWN MAPLE • RED OAK • QSWO • CHERRY • HARD MAPLE • HICKORY • RUSTIC CHERRY • RUSTIC HICKORY • RUSTIC QSWO  
RUSTIC WALNUT • SAP CHERRY • WALNUT • WORMY MAPLE • PLAIN SAWN WHITE OAK • RUSTIC PLAIN SAWN WHITE OAK

## SHAPE OPTIONS



RECTANGLE

## EDGE OPTIONS



MISSION



# CHEYENNE LEG

- 1¼" Rectangle top with Mission edge standard
- Floor to bottom of skirt 26½"
- Available in 36" height
- Shown in Rough Sawn Wormy Maple with FC-42000 Almond, 10 sheen finish  
(Note: Actual color may vary from picture)



## SIZES

36" X 42"	Up to 4-12" leaves	Self-store NOT available
36" X 48"	Up to 4-12" leaves	Stores up to 2 leaves, 1 w/skirts & 1 w/o
36" X 54"	Up to 4-12" leaves	Stores up to 2 leaves, 1 w/skirts & 1 w/o
42" X 42"	Up to 4-12" leaves	Self-store NOT available
42" X 48"	Up to 4-12" leaves	Self-store NOT available
42" X 54"	Up to 4-12" leaves	Stores up to 4 leaves, 2 w/skirts & 2 w/o

## SPECIES

ROUGH SAWN WORMY MAPLE

## SHAPE OPTIONS



RECTANGLE

## EDGE OPTIONS



MISSION

# CHEYENNE BENCH

- 1¼" Rectangle top with Mission edge standard
- Leaf storage box to store all 4 leaves
- Solid tops will not have center legs
- Fabric or Leather bench top available – solid top only. See page 32 for details.
- Shown in Rough Sawn Wormy Maple with FC-24427 Shadow 10 sheen top and FC-47823 Bel Air 10 sheen base (Note: Actual color may vary from picture)



## SIZES

- 12 ½" X 48" Solid top or up to 4-12" leaves
- 12 ½" X 54" Solid top or up to 4-12" leaves

## SPECIES

ROUGH SAWN WORMY MAPLE

## SHAPE OPTIONS



RECTANGLE

## EDGE OPTIONS



MISSION





# COLBY LEG



- 1" Rectangle top with Mission edge standard
- Legs standard as shown
- Floor to bottom of skirt 25½"
- Available in 36" height
- Shown in Brown Maple with FC-42000 Almond  
(Note: Actual color may vary from picture)



## SIZES

42" X 60"	Up to 4-12" leaves	Stores up to 4 leaves, 2 w/skirts & 2 w/o
42" X 66"	Up to 4-12" leaves	Stores up to 4 leaves, 2 w/skirts & 2 w/o
42" X 72"	Up to 4-12" leaves	Stores up to 4 leaves, 2 w/skirts & 2 w/o
48" X 60"	Up to 4-12" leaves	Stores up to 4 leaves, 2 w/skirts & 2 w/o
48" X 66"	Up to 4-12" leaves	Stores up to 4 leaves, 2 w/skirts & 2 w/o
48" X 72"	Up to 4-12" leaves	Stores up to 4 leaves, 2 w/skirts & 2 w/o

Available 84" long, N/A with butterfly leaves. See pricelist for details.

For more than 4 leaves, see page 33

## SPECIES

BROWN MAPLE • RED OAK • QSWO • CHERRY • HARD MAPLE • HICKORY • RUSTIC CHERRY • RUSTIC HICKORY • RUSTIC QSWO  
RUSTIC WALNUT • SAP CHERRY • WALNUT • WORMY MAPLE • PLAIN SAWN WHITE OAK • RUSTIC PLAIN SAWN WHITE OAK

## SHAPE OPTIONS



RECTANGLE  
(STANDARD)



1" RADIUS  
CORNER



BOW END

## EDGE OPTIONS



MISSION  
(STANDARD)



5/8" ROUND OVER



WATERFALL



BEVEL



CHAMFER

# COLEBROOK TRESTLE

- 1" Boat shape top with Bevel edge standard
- Black inlay in top & base
- Floor to bottom of skirt 26½"
- Available in 36" height
- Recommended chair: Colebrook from RH Yoder



## SIZES

42" X 60"	Up to 4-12" leaves or 1-18" butterfly leaf	Stores up to 2 unskirted leaves
42" X 66"	Up to 4-12" leaves or up to 2-18" butterfly leaves	Stores up to 4 leaves, 2 w/skirts & 2 w/o
42" X 72"	Up to 4-12" leaves or up to 2-18" butterfly leaves	Stores up to 4 leaves, 2 w/skirts & 2 w/o
48" X 60"	Up to 4-12" leaves or 1-18" butterfly leaf	Stores up to 4 leaves, 2 w/skirts & 2 w/o
48" X 66"	Up to 4-12" leaves or up to 2-18" butterfly leaves	Stores up to 4 unskirted leaves
48" X 72"	Up to 4-12" leaves or up to 2-18" butterfly leaves	Stores up to 4 unskirted leaves

Available 84" long, N/A with butterfly leaves. See pricelist for details.

For more than 4 leaves, see page 33

## SPECIES

BROWN MAPLE • RED OAK • QSWO • CHERRY • HARD MAPLE • HICKORY • RUSTIC CHERRY • RUSTIC HICKORY • RUSTIC QSWO  
RUSTIC WALNUT • SAP CHERRY • WALNUT • WORMY MAPLE • PLAIN SAWN WHITE OAK • RUSTIC PLAIN SAWN WHITE OAK

## SHAPE OPTIONS



Changing the top shape may affect self-store ability

## EDGE OPTIONS



## COLEBROOK TRESTLE

shown in Quarter  
Sawn White Oak with  
Michael's Cherry stain.  
Shown with RH Yoder  
Colebrook Chairs.

*(Note: Actual color  
may vary from picture)*







# COLEBROOK BENCH

- 1" Rectangle top with Mission edge standard
- 18" high
- Leaf storage box to store all 4 leaves
- Solid tops will not have center legs
- Fabric or Leather bench top available – solid top only. See page 32 for details.



## SIZES

12 ½" X 48"	Solid top or up to 4-12" leaves
12 ½" X 60"	Solid top or up to 4-12" leaves
12 ½" X 72"	Solid top or up to 4-12" leaves

## SPECIES

BROWN MAPLE • RED OAK • QSWO • CHERRY • HARD MAPLE • HICKORY • RUSTIC CHERRY • RUSTIC HICKORY • RUSTIC QSWO  
RUSTIC WALNUT • SAP CHERRY • WALNUT • WORMY MAPLE • PLAIN SAWN WHITE OAK • RUSTIC PLAIN SAWN WHITE OAK

## SHAPE OPTIONS



RECTANGLE

## EDGE OPTIONS



MISSION



# COLUMBUS TRESTLE



42" X 72"  
2-12" S/S leaves  
Rough Sawn  
Wormy Maple  
Standard shape & edge

- 1¼" Rectangle top with Mission edge standard
- Base standard as shown with levelers
- Authentic "thru-tenon" in base
- Floor to bottom of skirt 26½"
- Not available in pub height
- Shown in Rough Sawn Wormy Maple with FC-42000 Almond 10 sheen finish  
*(Note: Actual color may vary from picture)*



## SIZES

42" X 60"	Up to 4-12" leaves	Stores up to 4 unskirted leaves
42" X 66"	Up to 4-12" leaves	Stores up to 4 leaves, 2 w/skirts & 2 w/o
42" X 72"	Up to 4-12" leaves	Stores up to 4 leaves, 2 w/skirts & 2 w/o
48" X 60"	Up to 4-12" leaves	Stores up to 4 leaves, 2 w/skirts & 2 w/o
48" X 66"	Up to 4-12" leaves	Stores up to 4 unskirted leaves
48" X 72"	Up to 4-12" leaves	Stores up to 4 unskirted leaves

Available 84" long, N/A with butterfly leaves. See pricelist for details.

## SPECIES

ROUGH SAWN WORMY MAPLE

## SHAPE OPTIONS



RECTANGLE

## EDGE OPTIONS



MISSION





## COLUMBUS TRESTLE

shown in Rough Sawn  
Wormy Maple with  
FC-42000 Almond  
10 sheen finish.  
Shown with Artisan  
Columbus Chairs.

*(Note: Actual color  
may vary from picture)*









# COLUMBUS BENCH

- 1¼" Rectangle top with Mission edge standard
- Leaf storage box to store all 4 leaves
- Solid tops will not have center legs
- Fabric or Leather bench top available – solid top only. See page 32 for details.
- Shown in Rough Sawn Wormy Maple with FC-42000 Almond 10 sheen finish  
(Note: Actual color may vary from picture)



12½" X 72" 2-12" leaf  
Rough Sawn  
Wormy Maple  
Standard shape & edge



## SIZES

- |             |                                 |
|-------------|---------------------------------|
| 12 ½" X 48" | Solid top or up to 4-12" leaves |
| 12 ½" X 60" | Solid top or up to 4-12" leaves |
| 12 ½" X 72" | Solid top or up to 4-12" leaves |

## SPECIES

ROUGH SAWN WORMY MAPLE

## SHAPE OPTIONS



RECTANGLE

## EDGE OPTIONS



MISSION



# DALLAS TRESTLE

- 1¼" Rectangle top with Mission edge standard
- Base standard as shown with levelers
- Floor to bottom of skirt 26½"
- Available in 36" height
- Shown in Rough Sawn White Oak with PCL-173 Desert Dusk, 10 sheen finish  
*(Note: Actual color may vary from picture)*



## SIZES

36" X 48"	Up to 3-12" leaves	Stores up to 2 unskirted leaves
36" X 54"	Up to 3-12" leaves	Stores up to 2 unskirted leaves
36" X 60"	Up to 3-12" leaves	Stores up to 2 unskirted leaves
42" X 48"	Up to 3-12" leaves	Self-store NOT available
42" X 54"	Up to 3-12" leaves	Stores up to 3 unskirted leaves
42" X 60"	Up to 3-12" leaves	Stores up to 3 unskirted leaves

## SPECIES

ROUGH SAWN WORMY MAPLE • ROUGH SAWN WHITE OAK

## SHAPE OPTIONS



RECTANGLE

## EDGE OPTIONS



MISSION



# DAYTON LEG

- 1" smooth Rectangle top with grain lengthwise and Mission edge standard
- 2 ½" x 2 ½" x 29" taper shaker legs standard
- Floor to bottom of skirt 26½"
- Available in 36" height



## SIZES

42" X 30"	Solid top only
42" X 33"	Solid top only
42" X 36"	Solid top only
48" X 30"	Solid top only
48" X 33"	Solid top only
48" X 36"	Solid top only

## SPECIES

BROWN MAPLE • RED OAK • QSWO • CHERRY • HARD MAPLE • HICKORY • RUSTIC CHERRY • RUSTIC HICKORY • RUSTIC QSWO  
RUSTIC WALNUT • SAP CHERRY • WALNUT • WORMY MAPLE • PLAIN SAWN WHITE OAK • RUSTIC PLAIN SAWN WHITE OAK

## SHAPE OPTIONS



RECTANGLE  
(STANDARD)



1" RADIUS  
CORNER

## EDGE OPTIONS



MISSION  
(STANDARD)



5/8" ROUNDOVER



WATERFALL



BEVEL



CHAMFER

# DENVER LEG



42" X 72" 30" high  
2-12" S/S leaves  
Red Oak or  
Rustic Hickory  
Standard shape & edge

- 1" Rectangle top with Bevel edge standard
- 2½" straight skirt standard
- Non-g geared wooden slides
- Floor to bottom of skirt 26½"
- Available in 36" height



## SIZES

42" X 60"	Up to 4-12" leaves or 1-18" butterfly leaf	Stores up to 4 leaves, 2 w/skirts & 2 w/o
42" X 66"	Up to 4-12" leaves or 1-18" butterfly leaf	Stores up to 4 leaves, 2 w/skirts & 2 w/o
42" X 72"	Up to 4-12" leaves or 1-18" butterfly leaf	Stores up to 4 leaves, 2 w/skirts & 2 w/o
48" X 60"	Up to 4-12" leaves or 1-18" butterfly leaf	Stores up to 4 leaves, 2 w/skirts & 2 w/o
48" X 66"	Up to 4-12" leaves or 1-18" butterfly leaf	Stores up to 4 leaves, 2 w/skirts & 2 w/o
48" X 72"	Up to 4-12" leaves or 1-18" butterfly leaf	Stores up to 4 leaves, 2 w/skirts & 2 w/o

Available 84" long, N/A with butterfly leaves. See pricelist for details.

For more than 4 leaves, see page 33

## SPECIES

BROWN MAPLE • RED OAK • QSWO • CHERRY • HARD MAPLE • HICKORY • RUSTIC CHERRY • RUSTIC HICKORY • RUSTIC QSWO  
RUSTIC WALNUT • SAP CHERRY • WALNUT • WORMY MAPLE • PLAIN SAWN WHITE OAK • RUSTIC PLAIN SAWN WHITE OAK

## SHAPE OPTIONS



RECTANGLE  
(STANDARD)



1" RADIUS  
CORNER



BOW END



BOAT

Changing the top shape may affect self-store ability

## EDGE OPTIONS



MISSION



5/8" ROUNDOVER



WATERFALL



BEVEL  
(STANDARD)



CHAMFER





## DENVER LEG

shown in Brown Maple  
with FC-40592  
Earthtone stain.  
Shown with FN  
Ramsey Chairs.

*(Note: Actual color  
may vary from picture)*









# DENVER BENCH

- 1" Rectangle top with Mission edge
- 18" high
- Leaf storage box to store all 4 leaves
- Solid tops will not have center legs
- Fabric or Leather bench top available – solid top only. See page 32 for details.



## SIZES

- 12 ½" X 48" Solid top or up to 4-12" leaves
- 12 ½" X 60" Solid top or up to 4-12" leaves
- 12 ½" X 72" Solid top or up to 4-12" leaves

## SPECIES

BROWN MAPLE • RED OAK • QSWO • CHERRY • HARD MAPLE • HICKORY • RUSTIC CHERRY • RUSTIC HICKORY • RUSTIC QSWO  
RUSTIC WALNUT • SAP CHERRY • WALNUT • WORMY MAPLE • PLAIN SAWN WHITE OAK • RUSTIC PLAIN SAWN WHITE OAK

## SHAPE OPTIONS



RECTANGLE

## EDGE OPTIONS



MISSION



# DOVER LEG

- 1" Rectangle top with Mission edge standard
- 2½" straight skirt
- 2½" x 2½" x 29" taper shaker legs standard
- Floor to bottom of skirt 26½"
- Available in 36" height



36" X 48" 30" high  
2-12" S/S leaves  
Red Oak or  
Brown Maple  
Standard shape & edge



## SIZES

36" X 42"	Up to 4-12" leaves	Self-store NOT available
36" X 48"	Up to 4-12" leaves	Stores up to 2 leaves, 1 w/skirts & 1 w/o
36" X 54"	Up to 4-12" leaves	Stores up to 2 leaves, 1 w/skirts & 1 w/o
42" X 42"	Up to 4-12" leaves	Self-store NOT available
42" X 48"	Up to 4-12" leaves	Self-store NOT available
42" X 54"	Up to 4-12" leaves	Stores up to 4 leaves, 2 w/skirts & 2 w/o

## SPECIES

BROWN MAPLE • RED OAK • QSWO • CHERRY • HARD MAPLE • HICKORY • RUSTIC CHERRY • RUSTIC HICKORY • RUSTIC QSWO  
RUSTIC WALNUT • SAP CHERRY • WALNUT • WORMY MAPLE • PLAIN SAWN WHITE OAK • RUSTIC PLAIN SAWN WHITE OAK

## SHAPE OPTIONS



RECTANGLE  
(STANDARD)



1" RADIUS  
CORNER



BOW END

## EDGE OPTIONS



MISSION  
(STANDARD)



5/8" ROUNDOVER



WATERFALL



BEVEL



CHAMFER



## DOVER LEG

shown in Red Oak  
with FC-47865 Grey  
Flannel stain.  
Shown with FN  
Lodge Chairs.

*(Note: Actual color  
may vary from picture)*









# DURANGO TRESTLE



- 3" Edge band top with 1/4" roundover corners and edge standard
- Black powder coated metal base with wood stretcher
- Base standard as shown with levelers
- Floor to bottom of top 27"
- Not available in pub height
- Shown in Rustic Walnut with Natural finish  
(Note: Actual color may vary from picture)



## SIZES

42" X 84"	Solid top only
42" X 96"	Solid top only
42" X 108"	Solid top only
42" X 120"	Solid top only
48" X 84"	Solid top only
48" X 96"	Solid top only
48" X 108"	Solid top only
48" X 120"	Solid top only

## SPECIES

BROWN MAPLE • RED OAK • QSWO • CHERRY • RUSTIC CHERRY • RUSTIC QSWO • RUSTIC WALNUT  
SAP CHERRY • WALNUT • WORMY MAPLE • PLAIN SAWN WHITE OAK • RUSTIC PLAIN SAWN WHITE OAK  
N/A IN GREY ELM, HARD MAPLE, HICKORY, RUSTIC HICKORY

## SHAPE OPTIONS



1/4" RADIUS  
CORNER

## EDGE OPTIONS



1/4" ROUNDOVER

# DURANGO DOUBLE BENCH



- 1¾" Rectangle top with Mission edge standard
- 18¾" high
- Black powder coated metal base with wood stretcher
- Shown in Rustic Walnut with Natural finish  
*(Note: Actual color may vary from picture)*



## SIZES

- 12 ½" X 84" Solid top only
- 12 ½" X 96" Solid top only

## SPECIES

BROWN MAPLE • RED OAK • QSWO • CHERRY • RUSTIC CHERRY • RUSTIC QSWO • RUSTIC WALNUT  
SAP CHERRY • WALNUT • WORMY MAPLE • PLAIN SAWN WHITE OAK • RUSTIC PLAIN SAWN WHITE OAK  
*N/A IN GREY ELM, HARD MAPLE, HICKORY, RUSTIC HICKORY*

## SHAPE OPTIONS



RECTANGLE

## EDGE OPTIONS



MISSION



# DURANGO TRIPLE BENCH



- 1¾" Rectangle top with Mission edge standard
- 18¾" high
- Black powder coated metal base with wood stretcher
- Shown in Rustic Walnut with Natural finish  
(Note: Actual color may vary from picture)



## SIZES

- 12 ½" X 108" Solid top only
- 12 ½" X 120" Solid top only

## SPECIES

BROWN MAPLE • RED OAK • QSWO • CHERRY • RUSTIC CHERRY • RUSTIC QSWO • RUSTIC WALNUT  
SAP CHERRY • WALNUT • WORMY MAPLE • PLAIN SAWN WHITE OAK • RUSTIC PLAIN SAWN WHITE OAK  
N/A IN GREY ELM, HARD MAPLE, HICKORY, RUSTIC HICKORY

## SHAPE OPTIONS



RECTANGLE

## EDGE OPTIONS



MISSION



# DUTCH DOUBLE

- 1" top with 8" Square Round with Roundover edge standard
- Base standard as shown with levelers
- Not available in pub height
- Floor to bottom of skirt 26½"



## SIZES

42" X 60"	Up to 4-12" leaves	Stores up to 4 unskirted leaves
42" X 66"	Up to 4-12" leaves	Stores up to 4 unskirted leaves
42" X 72"	Up to 4-12" leaves	Stores up to 4 unskirted leaves
48" X 60"	Up to 4-12" leaves	Stores up to 4 unskirted leaves
48" X 66"	Up to 4-12" leaves	Stores up to 4 unskirted leaves
48" X 72"	Up to 4-12" leaves	Stores up to 4 unskirted leaves

For more than 4 leaves, see page 33

## SPECIES

BROWN MAPLE • RED OAK • QSWO • CHERRY • HARD MAPLE • HICKORY • RUSTIC CHERRY • RUSTIC HICKORY • RUSTIC QSWO  
RUSTIC WALNUT • SAP CHERRY • WALNUT • WORMY MAPLE • PLAIN SAWN WHITE OAK • RUSTIC PLAIN SAWN WHITE OAK

## SHAPE OPTIONS



RECTANGLE



1" RADIUS  
CORNER



BOW END



8" SQUARE  
ROUND (STD)

Changing the top shape may affect self-store ability

## EDGE OPTIONS



MISSION



5/8" ROUNDOVER  
(STANDARD)



WATERFALL



BEVEL



CHAMFER



# EASTON SINGLE

- 1" Round top with Waterfall edge
- Base standard as shown with levelers
- Floor to bottom of skirt 26½"
- Available in 36" height



## SIZES

- 42" X 42" Round    Up to 2-12" leaves  
48" X 48" Round    Up to 2-12" leaves or 1-18" butterfly leaf

## SPECIES

BROWN MAPLE • RED OAK • QSWO • CHERRY • HARD MAPLE • HICKORY • RUSTIC CHERRY • RUSTIC HICKORY • RUSTIC QSWO  
RUSTIC WALNUT • SAP CHERRY • WALNUT • WORMY MAPLE • PLAIN SAWN WHITE OAK • RUSTIC PLAIN SAWN WHITE OAK

## SHAPE OPTIONS



ROUND

## EDGE OPTIONS



MISSION



5/8" ROUNDOVER



WATERFALL  
(STANDARD)



BEVEL



CHAMFER

# EL PASO TRESTLE

- 1¾" Rectangle top with Mission edge standard
- Authentic "thru-tenon" in base
- Recommended chair: Houston from FN Chairs
- Floor to bottom of skirt 26½"
- The 68" table will only fit one chair per side
- Available in 36" height
- Shown in Rough Sawn Wormy Maple with FC-42000 Almond 10 sheen  
*(Note: Actual color may vary from picture)*



48" X 80" 30" high  
2-16" leaf  
Rough Sawn  
Wormy Maple  
Standard shape & edge



## SIZES

42" X 68"	Up to 3-16" leaves	Self-store not available
42" X 80"	Up to 3-16" leaves	Self-store not available
48" X 68"	Up to 3-16" leaves	Self-store not available
48" X 80"	Up to 3-16" leaves	Self-store not available

## SPECIES

ROUGH SAWN WORMY MAPLE

## SHAPE OPTIONS



RECTANGLE

## EDGE OPTIONS



MISSION





## EL PASO TRESTLE

shown in Rough Sawn  
Wormy Maple with  
FC-42000 Almond  
10 sheen finish. Shown  
with FN Chairs  
Houston Chairs.

*(Note: Actual color  
may vary from picture)*









# EL PASO BENCH

- 1¾" Rectangle top with Mission standard
- Solid tops will not have center legs
- Shown in Rough Sawn Wormy Maple with FC-42000 Almond, 10 sheen finish  
(Note: Actual color may vary from picture)



12½" X 80" 2-16" leaf  
Rough Sawn  
Wormy Maple  
Standard shape & edge



## SIZES

- 12 ½" X 68" Solid top or up to 3-16" leaves  
12 ½" X 80" Solid top or up to 3-16" leaves

## SPECIES

ROUGH SAWN WORMY MAPLE

## SHAPE OPTIONS



RECTANGLE

## EDGE OPTIONS



MISSION



# ELLIANNA CABINET



- 1" top with 1" radius corners with Mission edge standard
- Base standard as shown with levelers
- K2040-BL hardware standard
- Cabinet base is 26" w x 26" d (no options)
- Side mount drawer slides
- 36" high standard. Also available in 30" & 42" h (30" h only has 2 drawers)
- Floor to bottom of skirt 32½"
- Not available with Round top
- Shown in Brown Maple with FC-107 Harvest stain (*Note: Actual color may vary from picture*)



## SIZES

- 42" X 42" Solid top, 1-12" leaf, or 1-18" butterfly leaf
- 42" X 48" Solid top, 1-12" leaf, or 1-18" butterfly leaf
- 42" X 54" Solid top, 1-12" leaf, or 1-18" butterfly leaf
- 48" X 48" Solid top, 1-12" leaf, or 1-18" butterfly leaf
- 48" X 54" Solid top, 1-12" leaf, or 1-18" butterfly leaf

## SPECIES

BROWN MAPLE • RED OAK • QSWO • CHERRY • HARD MAPLE • HICKORY • RUSTIC CHERRY • RUSTIC HICKORY • RUSTIC QSWO  
RUSTIC WALNUT • SAP CHERRY • WALNUT • WORMY MAPLE • PLAIN SAWN WHITE OAK • RUSTIC PLAIN SAWN WHITE OAK

## SHAPE OPTIONS



RECTANGLE



1" RADIUS  
CORNER  
(STANDARD)



BOW END

## EDGE OPTIONS



MISSION  
(STANDARD)



5/8" ROUNDOVER



WATERFALL



BEVEL



CHAMFER



## ELLIANNA LEG

shown in Plain Sawn  
White Oak with Natural  
10 sheen finish. Shown  
with FN Ellianna Chairs.

*(Note: Actual color  
may vary from picture)*









# ELLIANNA LEG



42" X 72" 30" high  
2-12" S/S leaves  
Oak or Brown Maple  
Standard shape & edge

- 1" Rectangle top with 2" Radius corners and Mission edge standard
- Legs standard as shown
- Floor to bottom of skirt 26"
- Available in 36" height
- Shown in Plain Sawn White Oak with Natural 10 sheen finish  
(Note: Actual color may vary from picture)



## SIZES

42" X 60"	Up to 4-12" leaves	Stores up to 4 leaves, 2 w/skirts & 2 w/o
42" X 66"	Up to 4-12" leaves	Stores up to 4 leaves, 2 w/skirts & 2 w/o
42" X 72"	Up to 4-12" leaves	Stores up to 4 leaves, 2 w/skirts & 2 w/o
48" X 60"	Up to 4-12" leaves	Stores up to 4 leaves, 2 w/skirts & 2 w/o
48" X 66"	Up to 4-12" leaves	Stores up to 4 leaves, 2 w/skirts & 2 w/o
48" X 72"	Up to 4-12" leaves	Stores up to 4 leaves, 2 w/skirts & 2 w/o

Available 84" long, N/A with butterfly leaves. See pricelist for details.

For more than 4 leaves, see page 33

## SPECIES

BROWN MAPLE • RED OAK • QSWO • CHERRY • HARD MAPLE • HICKORY • RUSTIC CHERRY • RUSTIC HICKORY • RUSTIC QSWO  
RUSTIC WALNUT • SAP CHERRY • WALNUT • WORMY MAPLE • PLAIN SAWN WHITE OAK • RUSTIC PLAIN SAWN WHITE OAK

## SHAPE OPTIONS



2" RADIUS  
CORNER

## EDGE OPTIONS



MISSION  
(STANDARD)



5/8" ROUNDOVER



WATERFALL



BEVEL



CHAMFER

# ELWOOD LEG



- 1" Rectangle top with 4" radius corners and Mission edge standard
- Legs standard as shown
- No gap cover (not available)
- Floor to bottom of skirt 26"
- Available in 36" height
- Shown in Brown Maple with D22N11322 Granola, 10 sheen finish  
*(Note: Actual color may vary from picture)*



## SIZES

42" X 60"	Up to 4-12" leaves	Stores up to 4 leaves, 2 w/skirts & 2 w/o
42" X 66"	Up to 4-12" leaves	Stores up to 4 leaves, 2 w/skirts & 2 w/o
42" X 72"	Up to 4-12" leaves	Stores up to 4 leaves, 2 w/skirts & 2 w/o
48" X 60"	Up to 4-12" leaves	Stores up to 4 leaves, 2 w/skirts & 2 w/o
48" X 66"	Up to 4-12" leaves	Stores up to 4 leaves, 2 w/skirts & 2 w/o
48" X 72"	Up to 4-12" leaves	Stores up to 4 leaves, 2 w/skirts & 2 w/o

Available 84" long, N/A with butterfly leaves. See pricelist for details.

For more than 4 leaves, see page 33

## SPECIES

BROWN MAPLE • RED OAK • QSWO • CHERRY • HARD MAPLE • HICKORY • RUSTIC CHERRY • RUSTIC HICKORY • RUSTIC QSWO  
RUSTIC WALNUT • SAP CHERRY • WALNUT • WORMY MAPLE • PLAIN SAWN WHITE OAK • RUSTIC PLAIN SAWN WHITE OAK

## SHAPE OPTIONS



4" RADIUS CORNER

## EDGE OPTIONS



MISSION (STANDARD)



5/8" ROUNDOVER



WATERFALL



BEVEL



CHAMFER



# ETHAN LEG

- 1" Rectangle top with Mission edge standard
- 4½" straight skirt with molding, standard as shown
- 3" x 3" tapered leg with molding, standard as shown
- Not available with boat shape top
- Available in 36" height
- Floor to bottom of skirt 24½"
- 3½" skirts recommended for arm chairs (Floor to bottom of skirt is 25½")
- Shown in Brown Maple with FC-42633 Manchester finish (*Note: Actual color may vary from picture*)



## SIZES

42" X 60"	Up to 4-12" leaves	Stores up to 4 leaves, 2 w/skirts & 2 w/o
42" X 66"	Up to 4-12" leaves	Stores up to 4 leaves, 2 w/skirts & 2 w/o
42" X 72"	Up to 4-12" leaves	Stores up to 4 leaves, 2 w/skirts & 2 w/o
48" X 60"	Up to 4-12" leaves	Stores up to 4 leaves, 2 w/skirts & 2 w/o
48" X 66"	Up to 4-12" leaves	Stores up to 4 leaves, 2 w/skirts & 2 w/o
48" X 72"	Up to 4-12" leaves	Stores up to 4 leaves, 2 w/skirts & 2 w/o

Available 84" long, N/A with butterfly leaves. See pricelist for details.

For more than 4 leaves, see page 33

## SPECIES

BROWN MAPLE • RED OAK • QSWO • CHERRY • HARD MAPLE • HICKORY • RUSTIC CHERRY • RUSTIC HICKORY • RUSTIC QSWO  
RUSTIC WALNUT • SAP CHERRY • WALNUT • WORMY MAPLE • PLAIN SAWN WHITE OAK • RUSTIC PLAIN SAWN WHITE OAK

## SHAPE OPTIONS



RECTANGLE  
(STANDARD)



1" RADIUS  
CORNER



BOW END

## EDGE OPTIONS



MISSION  
(STANDARD)



5/8" ROUNDOVER



WATERFALL



BEVEL



CHAMFER



# FENWAY TRESTLE PUB

- 1¼" Rectangle top with Mission edge and grain lengthwise standard
- Base standard as shown with levelers
- 36" high is standard. Not available in 30" or 42" high.
- Black powder coated metal footrail (no color options)
- Shown in Plain Sawn White Oak top with FC-107 Harvest 10 sheen & Brown Maple base with PCL-183 Muted White 10 sheen  
*(Note: Actual color may vary from picture)*



## SIZES

36" X 48"	Solid top only
36" X 54"	Solid top only
36" X 60"	Solid top only
36" X 72"	Solid top only

## SPECIES

BROWN MAPLE • RED OAK • QSWO • CHERRY • HARD MAPLE • HICKORY • RUSTIC CHERRY • RUSTIC HICKORY • RUSTIC QSWO  
RUSTIC WALNUT • SAP CHERRY • WALNUT • WORMY MAPLE • PLAIN SAWN WHITE OAK • RUSTIC PLAIN SAWN WHITE OAK

## SHAPE OPTIONS



RECTANGLE  
(STANDARD)



1" RADIUS  
CORNER

## EDGE OPTIONS



MISSION  
(STANDARD)



5/8" ROUNDOVER



WATERFALL



BEVEL



CHAMFER



# FORT WORTH SINGLE



- 1¼" Round top with Mission edge standard
- Base standard as shown with levelers
- Floor to bottom of skirt 26½"
- Available in 36" height
- Shown in Rough Sawn Wormy Maple with FC-42000 Almond 10 sheen finish  
*(Note: Actual color may vary from picture)*



## SIZES

48" X 48" Round	Up to 2-12" leaves
54" X 54" Round	Up to 2-12" leaves
60" X 60" Round	Up to 2-12" leaves
72" X 72" Round	Solid top only

## SPECIES

ROUGH SAWN WORMY MAPLE

## SHAPE OPTIONS



ROUND

## EDGE OPTIONS



MISSION

# FREMONT TRESTLE

- 1" top with 1" corner radius and Bevel edge standard
- Base standard as shown with levelers
- Available in 36" height
- Recommended chair: Fremont from Artisan Chairs
- Floor to bottom of skirt 26½"



## SIZES

42" X 60"	Up to 4-12" leaves or 1-18" butterfly leaf	Stores up to 4 unskirted leaves
42" X 66"	Up to 4-12" leaves or up to 2-18" butterfly leaves	Stores up to 4 leaves, 2 w/skirts & 2 w/o
42" X 72"	Up to 4-12" leaves or up to 2-18" butterfly leaves	Stores up to 4 leaves, 2 w/skirts & 2 w/o
48" X 60"	Up to 4-12" leaves or 1-18" butterfly leaf	Stores up to 4 leaves, 2 w/skirts & 2 w/o
48" X 66"	Up to 4-12" leaves or up to 2-18" butterfly leaves	Stores up to 4 unskirted leaves
48" X 72"	Up to 4-12" leaves or up to 2-18" butterfly leaves	Stores up to 4 unskirted leaves

Available 84" long, N/A with butterfly leaves. See pricelist for details.

For more than 4 leaves, see page 33

## SPECIES

BROWN MAPLE • RED OAK • QSWO • CHERRY • HARD MAPLE • HICKORY • RUSTIC CHERRY • RUSTIC HICKORY • RUSTIC QSWO  
RUSTIC WALNUT • SAP CHERRY • WALNUT • WORMY MAPLE • PLAIN SAWN WHITE OAK • RUSTIC PLAIN SAWN WHITE OAK

## SHAPE OPTIONS



Changing the top shape may affect self-store ability

## EDGE OPTIONS





# FULTON TRESTLE

- 1" Rectangle top with Mission edge standard
- Base standard as shown with levelers
- Floor to bottom of skirt 26½"
- Not available in pub height
- Shown in Brown Maple with FC-50240 Carbon top & RNC-1003 Icicle base  
(Note: Actual color may vary from picture)



## SIZES

36" X 48"	Up to 3-12" leaves	Stores up to 2 unskirted leaves
36" X 54"	Up to 3-12" leaves	Stores up to 2 unskirted leaves
36" X 60"	Up to 3-12" leaves	Stores up to 2 unskirted leaves
42" X 48"	Up to 3-12" leaves	Self-store NOT available
42" X 54"	Up to 3-12" leaves	Stores up to 3 unskirted leaves
42" X 60"	Up to 3-12" leaves	Stores up to 3 unskirted leaves

## SPECIES

BROWN MAPLE • RED OAK • QSWO • CHERRY • HARD MAPLE • HICKORY • RUSTIC CHERRY • RUSTIC HICKORY • RUSTIC QSWO  
RUSTIC WALNUT • SAP CHERRY • WALNUT • WORMY MAPLE • PLAIN SAWN WHITE OAK • RUSTIC PLAIN SAWN WHITE OAK

## SHAPE OPTIONS



RECTANGLE  
(STANDARD)



1" RADIUS  
CORNER



BOW END

## EDGE OPTIONS



MISSION  
(STANDARD)



5/8" ROUNDOVER



WATERFALL



BEVEL



CHAMFER

# GALENA TRESTLE



42" X 72" 30" high  
2-12" S/S leaves  
QSWO or  
Rustic Hickory  
Standard shape & edge

- 1" Bow End top with Waterfall edge standard
- Base standard as shown with levelers
- Floor to bottom of skirt 26½"
- Available in 36" height



## SIZES

42" X 60"	Up to 4-12" leaves or 1-18" butterfly leaf	Stores up to 4 unskirted leaves
42" X 66"	Up to 4-12" leaves or up to 2-18" butterfly leaves	Stores up to 4 leaves, 2 w/skirts & 2 w/o
42" X 72"	Up to 4-12" leaves or up to 2-18" butterfly leaves	Stores up to 4 leaves, 2 w/skirts & 2 w/o
48" X 60"	Up to 4-12" leaves or 1-18" butterfly leaf	Stores up to 4 leaves, 2 w/skirts & 2 w/o
48" X 66"	Up to 4-12" leaves or up to 2-18" butterfly leaves	Stores up to 4 unskirted leaves
48" X 72"	Up to 4-12" leaves or up to 2-18" butterfly leaves	Stores up to 4 unskirted leaves

Available 84" long, N/A with butterfly leaves. See pricelist for details.

For more than 4 leaves, see page 33

## SPECIES

BROWN MAPLE • RED OAK • QSWO • CHERRY • HARD MAPLE • HICKORY • RUSTIC CHERRY • RUSTIC HICKORY • RUSTIC QSWO  
RUSTIC WALNUT • SAP CHERRY • WALNUT • WORMY MAPLE • PLAIN SAWN WHITE OAK • RUSTIC PLAIN SAWN WHITE OAK

## SHAPE OPTIONS



Changing the top shape may affect self-store ability

## EDGE OPTIONS



## GALENA TRESTLE

shown in Quarter  
Sawn White Oak with  
FC-7992 Asbury Brown  
stain. Shown with  
Artisan Galena Chairs.

*(Note: Actual color  
may vary from picture)*







# GALENA BENCH

- 1" Rectangle top with Mission edge standard
- Solid tops will not have center legs
- Fabric or Leather bench top available – solid top only. See page 32 for details.
- Shown in Quarter Sawn White Oak with Asbury Brown stain (Note: Actual color may vary from picture)



## SIZES

- |             |                                 |
|-------------|---------------------------------|
| 12 ½" X 48" | Solid top or up to 4-12" leaves |
| 12 ½" X 60" | Solid top or up to 4-12" leaves |
| 12 ½" X 72" | Solid top or up to 4-12" leaves |

## SPECIES

BROWN MAPLE • RED OAK • QSWO • CHERRY • HARD MAPLE • HICKORY • RUSTIC CHERRY • RUSTIC HICKORY • RUSTIC QSWO  
RUSTIC WALNUT • SAP CHERRY • WALNUT • WORMY MAPLE • PLAIN SAWN WHITE OAK • RUSTIC PLAIN SAWN WHITE OAK

## SHAPE OPTIONS



RECTANGLE

## EDGE OPTIONS



MISSION

# HAMPTON LEG

- 1" Rectangle top with Bullnose edge
- 3½" rounded skirt standard as shown
- No gap covers
- Leg standard as shown, optional reeded leg
- Floor to bottom of skirt 25½"
- Not available in pub height



## SIZES

42" X 60"	Up to 4-12" leaves	Stores up to 2 leaves, 1 w/skirts & 1 w/o
42" X 66"	Up to 4-12" leaves	Stores up to 4 leaves, 2 w/skirts & 2 w/o
42" X 72"	Up to 4-12" leaves	Stores up to 4 leaves, 2 w/skirts & 2 w/o
48" X 60"	Up to 4-12" leaves	Stores up to 4 leaves, 2 w/skirts & 2 w/o
48" X 66"	Up to 4-12" leaves	Stores up to 4 leaves, 2 w/skirts & 2 w/o
48" X 72"	Up to 4-12" leaves	Stores up to 4 leaves, 2 w/skirts & 2 w/o

*For more than 4 leaves, see page 33*

## SPECIES

BROWN MAPLE • RED OAK • QSWO • CHERRY • HARD MAPLE • HICKORY • RUSTIC CHERRY • RUSTIC HICKORY • RUSTIC QSWO  
RUSTIC WALNUT • SAP CHERRY • WALNUT • WORMY MAPLE • PLAIN SAWN WHITE OAK • RUSTIC PLAIN SAWN WHITE OAK

## SHAPE OPTIONS



RECTANGLE

## EDGE OPTIONS



BULLNOSE





# HAMPTON TRESTLE

- 1" Rectangle top with Bullnose edge standard
- 3½" rounded skirt as shown
- No gap covers
- Floor to bottom of skirt 25½"
- Not available in pub height



## SIZES

42" X 60"	Up to 4-12" leaves	Stores up to 4 unskirted leaves
42" X 66"	Up to 4-12" leaves	Stores up to 4 leaves, 2 w/skirts & 2 w/o
42" X 72"	Up to 4-12" leaves	Stores up to 4 leaves, 2 w/skirts & 2 w/o
48" X 60"	Up to 4-12" leaves	Stores up to 4 leaves, 2 w/skirts & 2 w/o
48" X 66"	Up to 4-12" leaves	Stores up to 4 unskirted leaves
48" X 72"	Up to 4-12" leaves	Stores up to 4 unskirted leaves

*For more than 4 leaves, see page 33*

## SPECIES

BROWN MAPLE • RED OAK • QSWO • CHERRY • HARD MAPLE • HICKORY • RUSTIC CHERRY • RUSTIC HICKORY • RUSTIC QSWO  
RUSTIC WALNUT • SAP CHERRY • WALNUT • WORMY MAPLE • PLAIN SAWN WHITE OAK • RUSTIC PLAIN SAWN WHITE OAK

## SHAPE OPTIONS



RECTANGLE

## EDGE OPTIONS



BULLNOSE

# HAMPTON BENCH

- 1" Rectangle top with Mission edge
- 18" high
- Leaf storage box to store all 4 leaves
- Solid tops will not have center legs
- Fabric or Leather bench top available – solid top only. See page 32 for details.



## SIZES

- 12 ½" X 48" Solid top or up to 4-12" leaves
- 12 ½" X 60" Solid top or up to 4-12" leaves
- 12 ½" X 72" Solid top or up to 4-12" leaves

## SPECIES

BROWN MAPLE • RED OAK • QSWO • CHERRY • HARD MAPLE • HICKORY • RUSTIC CHERRY • RUSTIC HICKORY • RUSTIC QSWO  
RUSTIC WALNUT • SAP CHERRY • WALNUT • WORMY MAPLE • PLAIN SAWN WHITE OAK • RUSTIC PLAIN SAWN WHITE OAK

## SHAPE OPTIONS



RECTANGLE

## EDGE OPTIONS



MISSION



# HARRISON DOUBLE

- Oval top with Bevel edge standard
- Feet standard as shown with levelers
- Plain bar spreader
- Recommended chair: Meridan from FN Chairs
- Floor to bottom of skirt 26½"
- Available in 36" height



## SIZES

42" X 60"	Up to 4-12" leaves	2 leaf stores 1 w/skirts & 1 w/o	4 leaf cannot self-store
42" X 66"	Up to 4-12" leaves	2 leaf stores both with skirts	4 leaf stores 2 leaves, 1 w/skirts & 1 w/o
42" X 72"	Up to 4-12" leaves	2 leaf stores both with skirts	4 leaf stores 2 leaves, 1 w/skirts & 1 w/o
48" X 60"	Up to 4-12" leaves	2 leaf stores 1 w/skirts & 1 w/o	4 leaf cannot self-store
48" X 66"	Up to 4-12" leaves	2 leaf stores both with skirts	4 leaf stores 2 leaves, 1 w/skirts & 1 w/o
48" X 72"	Up to 4-12" leaves	2 leaf stores both with skirts	4 leaf stores 4 leaves, 2 w/skirts & 2 w/o

For more than 4 leaves, see page 33

## SPECIES

BROWN MAPLE • RED OAK • QSWO • CHERRY • HARD MAPLE • HICKORY • RUSTIC CHERRY • RUSTIC HICKORY • RUSTIC QSWO  
RUSTIC WALNUT • SAP CHERRY • WALNUT • WORMY MAPLE • PLAIN SAWN WHITE OAK • RUSTIC PLAIN SAWN WHITE OAK

## SHAPE OPTIONS



Changing the top shape may affect self-store ability

## EDGE OPTIONS





# HARRISON SINGLE

- 1" Round top with Bevel edge standard
- Base standard as shown with levelers
- Floor to bottom of skirt 26½"
- Available in 36" height



## SIZES

- |                 |  |
|-----------------|--|
| 42" X 42" Round | Up to 2-12" leaves                         |
| 48" X 48" Round | Up to 2-12" leaves or 1-18" butterfly leaf |
| 54" X 54" Round | Up to 2-12" leaves or 1-18" butterfly leaf |

## SPECIES

BROWN MAPLE • RED OAK • QSWO • CHERRY • HARD MAPLE • HICKORY • RUSTIC CHERRY • RUSTIC HICKORY • RUSTIC QSWO  
RUSTIC WALNUT • SAP CHERRY • WALNUT • WORMY MAPLE • PLAIN SAWN WHITE OAK • RUSTIC PLAIN SAWN WHITE OAK

## SHAPE OPTIONS



ROUND

## EDGE OPTIONS



MISSION



5/8" ROUNDOVER



WATERFALL



BEVEL  
(STANDARD)



CHAMFER



# HARTFORD TRESTLE

- 1" Bow End top with Mission edge standard
- Trestle base standard as shown (no options)
- All leaves will be skirted unless ordered without
- Floor to bottom of skirt 26½"
- Note: starting size cannot be less than 78" due to the space needed for the base
- Not available in pub height
- See expanded view below



## SIZES

42" X 78"    From 10-12" to 14-12" leaves    Self-store not available  
 48" X 78"    From 10-12" to 14-12" leaves    Self-store not available

## SPECIES

BROWN MAPLE • RED OAK • QSWO • CHERRY • HARD MAPLE • HICKORY • RUSTIC CHERRY • RUSTIC HICKORY • RUSTIC QSWO  
 RUSTIC WALNUT • SAP CHERRY • WALNUT • WORMY MAPLE • PLAIN SAWN WHITE OAK • RUSTIC PLAIN SAWN WHITE OAK

## SHAPE OPTIONS



RECTANGLE



1" RADIUS  
CORNER



BOW END  
(STANDARD)

## EDGE OPTIONS



MISSION  
(STANDARD)



5/8" ROUNDOVER



WATERFALL



BEVEL



CHAMFER

# HARVEST LEG

- 1½" Rectangle top with Mission edge standard
- 4½" Harvest legs are standard, no other leg options
- 4½" skirt standard; floor to bottom of skirt 24½"
- 3½" skirt recommended for arm chairs (floor to bottom of skirt is 25½")
- Available in 36" height
- Shown in Brown Maple with Asbury Brown Burnished (*Note: Actual color may vary from picture*)



## SIZES

42" X 60"	Up to 4-12" leaves	4 leaf stores 2 w/skirts & 2 w/o
42" X 66"	Up to 4-12" leaves	4 leaf stores 2 w/skirts & 2 w/o
42" X 72"	Up to 4-12" leaves	4 leaf stores 2 w/skirts & 2 w/o
48" X 60"	Up to 4-12" leaves	4 leaf stores 2 w/skirts & 2 w/o
48" X 66"	Up to 4-12" leaves	4 leaf stores 2 w/skirts & 2 w/o
48" X 72"	Up to 4-12" leaves	4 leaf stores 2 w/skirts & 2 w/o

Available 84" long, N/A with butterfly leaves. See pricelist for details.

For more than 4 leaves, see page 33

## SPECIES

BROWN MAPLE • RED OAK • QSWO • CHERRY • HARD MAPLE • HICKORY • RUSTIC CHERRY • RUSTIC HICKORY • RUSTIC QSWO  
RUSTIC WALNUT • SAP CHERRY • WALNUT • WORMY MAPLE • PLAIN SAWN WHITE OAK • RUSTIC PLAIN SAWN WHITE OAK

## SHAPE OPTIONS



RECTANGLE  
(STANDARD)



1" RADIUS  
CORNER



BOW END

## EDGE OPTIONS



MISSION  
(STANDARD)



5/8" ROUNDOVER



WATERFALL



BEVEL



CHAMFER





# HARVEST BENCH

- 1" Rectangle top with Mission edge
- 18" high
- Leaf storage box to store all 4 leaves
- Solid tops will not have center legs
- Fabric or Leather bench top available – solid top only. See page 32 for details.
- Shown in Brown Maple with Asbury Brown Burnished (*Note: Actual color may vary from picture*)



## SIZES

- |             |                                 |
|-------------|---------------------------------|
| 12 ½" X 48" | Solid top or up to 4-12" leaves |
| 12 ½" X 60" | Solid top or up to 4-12" leaves |
| 12 ½" X 72" | Solid top or up to 4-12" leaves |

## SPECIES

BROWN MAPLE • RED OAK • QSWO • CHERRY • HARD MAPLE • HICKORY • RUSTIC CHERRY • RUSTIC HICKORY • RUSTIC QSWO  
RUSTIC WALNUT • SAP CHERRY • WALNUT • WORMY MAPLE • PLAIN SAWN WHITE OAK • RUSTIC PLAIN SAWN WHITE OAK

## SHAPE OPTIONS



RECTANGLE

## EDGE OPTIONS



MISSION

# HEIDI CABINET

- 1" top with 1" radius corners & Mission edge standard
- Standard with 1-18" Butterfly leaf
- Standard with basket drawers featuring soft-close slides as shown
- Floor to bottom of skirt 32½"
- Not available with Round top
- Cabinet base is 26" w x 26" d (No options on cabinet size)
- 36" high standard. Also available in 30" h
- Shown with dark drawer baskets (standard)
- Shown in Brown Maple with SP-151 Weathered Black Med-Dis. 10 sheen top and SP-154 Washed Gray Med-Dis. 10 sheen base  
(Note: Actual color may vary from picture)



## SIZES

42" X 42"	Solid top, 1-12" leaf, or 1-18" butterfly leaf
42" X 48"	Solid top, 1-12" leaf, or 1-18" butterfly leaf
42" X 54"	Solid top, 1-12" leaf, or 1-18" butterfly leaf
48" X 48"	Solid top, 1-12" leaf, or 1-18" butterfly leaf
48" X 54"	Solid top, 1-12" leaf, or 1-18" butterfly leaf

## SPECIES

BROWN MAPLE • RED OAK • QSWO • CHERRY • HARD MAPLE • HICKORY • RUSTIC CHERRY • RUSTIC HICKORY • RUSTIC QSWO  
RUSTIC WALNUT • SAP CHERRY • WALNUT • WORMY MAPLE • PLAIN SAWN WHITE OAK • RUSTIC PLAIN SAWN WHITE OAK

## SHAPE OPTIONS



## EDGE OPTIONS



## HEIDI CABINET

shown in Brown Maple  
SP-151 Weathered  
Black Med. Distressed  
10 sheen and SP-154  
Washed Gray Med.  
Distressed 10 sheen  
base stain. Shown with  
Denver Chairs from  
Artisan Chairs.

*(Note: Actual color  
may vary from picture)*







## HEIDI LEG

shown in Brown Maple  
with FC-42000 Almond  
top & PCL-175 Mineral  
base. Shown with  
Artisan Garrison Chairs.

*(Note: Actual color  
may vary from picture)*









# HEIDI LEG

- 1" Rectangle top with Mission edge standard
- Arched skirt standard as shown
- 3" x 3" straight legs standard
- Floor to bottom of skirt is 24½" at the legs and 26½" at the center
- Available in 36" height



## SIZES

42" X 60"	Up to 4-12" leaves or 1-18" butterfly leaf	Stores up to 4 leaves, 2 w/skirts & 2 w/o
42" X 66"	Up to 4-12" leaves or 1-18" butterfly leaf	Stores up to 4 leaves, 2 w/skirts & 2 w/o
42" X 72"	Up to 4-12" leaves or 1-18" butterfly leaf	Stores up to 4 leaves, 2 w/skirts & 2 w/o
48" X 60"	Up to 4-12" leaves or 1-18" butterfly leaf	Stores up to 4 leaves, 2 w/skirts & 2 w/o
48" X 66"	Up to 4-12" leaves or 1-18" butterfly leaf	Stores up to 4 leaves, 2 w/skirts & 2 w/o
48" X 72"	Up to 4-12" leaves or 1-18" butterfly leaf	Stores up to 4 leaves, 2 w/skirts & 2 w/o

Available 84" long, N/A with butterfly leaves. See pricelist for details.

For more than 4 leaves, see page 33

## SPECIES

BROWN MAPLE • RED OAK • QSWO • CHERRY • HARD MAPLE • HICKORY • RUSTIC CHERRY • RUSTIC HICKORY • RUSTIC QSWO  
RUSTIC WALNUT • SAP CHERRY • WALNUT • WORMY MAPLE • PLAIN SAWN WHITE OAK • RUSTIC PLAIN SAWN WHITE OAK

## SHAPE OPTIONS



RECTANGLE  
(STANDARD)



1" RADIUS  
CORNER



BOW END

## EDGE OPTIONS



MISSION  
(STANDARD)



5/8" ROUND OVER



WATERFALL



BEVEL



CHAMFER

# HEIDI BENCH

- 1" Rectangle top with Mission edge
- 18" high
- Leaf storage box to store all 4 leaves
- Solid tops will not have center legs
- Fabric or Leather bench top available – solid top only. See page 32 for details.



## SIZES

- 12 ½" X 48" Solid top or up to 4-12" leaves
- 12 ½" X 60" Solid top or up to 4-12" leaves
- 12 ½" X 72" Solid top or up to 4-12" leaves

## SPECIES

BROWN MAPLE • RED OAK • QSWO • CHERRY • HARD MAPLE • HICKORY • RUSTIC CHERRY • RUSTIC HICKORY • RUSTIC QSWO  
RUSTIC WALNUT • SAP CHERRY • WALNUT • WORMY MAPLE • PLAIN SAWN WHITE OAK • RUSTIC PLAIN SAWN WHITE OAK

## SHAPE OPTIONS



RECTANGLE

## EDGE OPTIONS



MISSION



## IMPERIAL DOUBLE

shown in Brown  
Maple with FC-40592  
Earthtone stain.  
Shown with Artisan  
Baytown Chairs.

*(Note: Actual color  
may vary from picture)*







# IMPERIAL DOUBLE

- 1" Oval top with Bevel edge standard
- Base standard as shown
- Floor to bottom of skirt 26½"
- Available in 36" height



## SIZES

42" X 60"	Up to 4-12" leaves	2 leaf stores 1 w/skirts & 1 w/o	4 leaf cannot self-store
42" X 66"	Up to 4-12" leaves	2 leaf stores both with skirts	4 leaf stores 2 leaves, 1 w/skirts & 1 w/o
42" X 72"	Up to 4-12" leaves	2 leaf stores both with skirts	4 leaf stores 2 leaves, 1 w/skirts & 1 w/o
48" X 60"	Up to 4-12" leaves	2 leaf stores 1 w/skirts & 1 w/o	4 leaf cannot self-store
48" X 66"	Up to 4-12" leaves	2 leaf stores both with skirts	4 leaf stores 2 leaves, 1 w/skirts & 1 w/o
48" X 72"	Up to 4-12" leaves	2 leaf stores both with skirts	4 leaf stores 4 leaves, 2 w/skirts & 2 w/o

For more than 4 leaves, see page 33

## SPECIES

BROWN MAPLE • RED OAK • QSWO • CHERRY • HARD MAPLE • HICKORY • RUSTIC CHERRY • RUSTIC HICKORY • RUSTIC QSWO  
RUSTIC WALNUT • SAP CHERRY • WALNUT • WORMY MAPLE • PLAIN SAWN WHITE OAK • RUSTIC PLAIN SAWN WHITE OAK

## SHAPE OPTIONS



Changing the top shape may affect self-store ability

## EDGE OPTIONS





# IMPERIAL SINGLE



48" X 48" 30" high  
2-12" leaves  
Brown Maple  
Standard shape & edge

- 1" Round top with Bevel edge standard
- Base standard as shown
- Floor to bottom of skirt 26½"
- Shown in Brown Maple with Michael's Cherry stain  
*(Note: Actual color may vary from picture)*



## SIZES

- |                 |  |
|-----------------|--|
| 42" X 42" Round | Up to 2-12" leaves                         |
| 48" X 48" Round | Up to 2-12" leaves or 1-18" butterfly leaf |
| 54" X 54" Round | Up to 2-12" leaves or 1-18" butterfly leaf |

## SPECIES

BROWN MAPLE • RED OAK • QSWO • CHERRY • HARD MAPLE • HICKORY • RUSTIC CHERRY • RUSTIC HICKORY • RUSTIC QSWO  
RUSTIC WALNUT • SAP CHERRY • WALNUT • WORMY MAPLE • PLAIN SAWN WHITE OAK • RUSTIC PLAIN SAWN WHITE OAK

## SHAPE OPTIONS



ROUND

## EDGE OPTIONS



MISSION



5/8" ROUNDOVER



WATERFALL



BEVEL  
(STANDARD)



CHAMFER





# IMPERIAL SINGLE PUB

- 1" Round top with Bevel edge standard
- Base standard as shown with levelers
- Floor to bottom of skirt 32½"
- Pub height standard 36" high (not available in 42" high)



## SIZES

- 42" X 42" Round Up to 2-12" leaves
- 48" X 48" Round Up to 2-12" leaves or 1-18" butterfly leaf
- 54" X 54" Round Solid top only

## SPECIES

BROWN MAPLE • RED OAK • QSWO • CHERRY • HARD MAPLE • HICKORY • RUSTIC CHERRY • RUSTIC HICKORY • RUSTIC QSWO  
RUSTIC WALNUT • SAP CHERRY • WALNUT • WORMY MAPLE • PLAIN SAWN WHITE OAK • RUSTIC PLAIN SAWN WHITE OAK

## SHAPE OPTIONS



ROUND

## EDGE OPTIONS



MISSION



5/8" ROUNDOVER



WATERFALL



BEVEL  
(STANDARD)



CHAMFER

# JAMESTOWN TRESTLE

- 1" Rectangle top with Mission edge standard
- Base standard as shown with levelers
- Not available in pub height
- Floor to bottom of skirt 26½"
- Recommended chair: Jamestown from Artisan Chairs



## SIZES

42" X 60"	Up to 4-12" leaves or 1-18" butterfly leaf	Stores up to 4 unskirted leaves
42" X 66"	Up to 4-12" leaves or up to 2-18" butterfly leaves	Stores up to 4 leaves, 2 w/skirts & 2 w/o
42" X 72"	Up to 4-12" leaves or up to 2-18" butterfly leaves	Stores up to 4 leaves, 2 w/skirts & 2 w/o
48" X 60"	Up to 4-12" leaves or 1-18" butterfly leaf	Stores up to 4 leaves, 2 w/skirts & 2 w/o
48" X 66"	Up to 4-12" leaves or up to 2-18" butterfly leaves	Stores up to 4 unskirted leaves
48" X 72"	Up to 4-12" leaves or up to 2-18" butterfly leaves	Stores up to 4 unskirted leaves

Available 84" long, N/A with butterfly leaves. See pricelist for details.

For more than 4 leaves, see page 33

## SPECIES

BROWN MAPLE • RED OAK • QSWO • CHERRY • HARD MAPLE • HICKORY • RUSTIC CHERRY • RUSTIC HICKORY • RUSTIC QSWO  
RUSTIC WALNUT • SAP CHERRY • WALNUT • WORMY MAPLE • PLAIN SAWN WHITE OAK • RUSTIC PLAIN SAWN WHITE OAK

## SHAPE OPTIONS



RECTANGLE  
(STANDARD)



1" RADIUS  
CORNER



BOW END



8" SQUARE  
ROUND



BOAT



BANQUET

Changing the top shape may affect self-store ability

## EDGE OPTIONS



MISSION  
(STANDARD)



5/8" ROUNDOVER



WATERFALL



BEVEL



CHAMFER



# KINGSBURY MISSION TRESTLE

- 1" Rectangle top with Mission edge standard
- Trestle base is 24" wide
- Floor to bottom of skirt 26½"
- Not available in pub height



## SIZES

42" X 60"	Up to 4-12" leaves or 1-18" butterfly leaf	Stores up to 4 unskirted leaves
42" X 66"	Up to 4-12" leaves or up to 2-18" butterfly leaves	Stores up to 4 leaves, 2 w/skirts & 2 w/o
42" X 72"	Up to 4-12" leaves or up to 2-18" butterfly leaves	Stores up to 4 leaves, 2 w/skirts & 2 w/o
48" X 60"	Up to 4-12" leaves or 1-18" butterfly leaf	Stores up to 4 leaves, 2 w/skirts & 2 w/o
48" X 66"	Up to 4-12" leaves or up to 2-18" butterfly leaves	Stores up to 4 unskirted leaves
48" X 72"	Up to 4-12" leaves or up to 2-18" butterfly leaves	Stores up to 4 unskirted leaves

Available 84" long, N/A with butterfly leaves. See pricelist for details.

For more than 4 leaves, see page 33

## SPECIES

BROWN MAPLE • RED OAK • QSWO • CHERRY • HARD MAPLE • HICKORY • RUSTIC CHERRY • RUSTIC HICKORY • RUSTIC QSWO  
RUSTIC WALNUT • SAP CHERRY • WALNUT • WORMY MAPLE • PLAIN SAWN WHITE OAK • RUSTIC PLAIN SAWN WHITE OAK

## SHAPE OPTIONS



Changing the top shape may affect self-store ability

## EDGE OPTIONS





# LAMESA TRESTLE

- 1½" Rectangle top with Live edge on ends standard
- Ball bearing slides are standard
- Base standard as shown with levelers
- Every Live edge top is unique and will vary from top to top
- Floor to bottom of skirt 26½"
- Not available in pub height
- Shown in Rustic Walnut with Natural finish  
*(Note: Actual color may vary from picture)*



## SIZES

42" X 72" Up to 4-12" leaves

48" X 72" Up to 4-12" leaves

**NOT AVAILABLE IN 60" LENGTH**

Stores up to 2 leaves, both with skirts

Stores up to 2 leaves, both without skirts

## SPECIES

RUSTIC CHERRY • RUSTIC WALNUT • WORMY MAPLE

## SHAPE OPTIONS



RECTANGLE

## EDGE OPTIONS



LIVE/MISSION



# LAPORTE TRESTLE

- 1½" Rectangle top with Live edge standard
- Base standard as shown with levelers
- Every Live edge top is unique and will vary from top to top
- Not available in pub height
- Shown in Rustic Walnut with Natural finish  
(Note: Actual color may vary from picture)



## **SIZES**

42" X 72"	Solid top only
42" X 84"	Solid top only
42" X 96"	Solid top only
42" X 108"	Solid top only
48" X 72"	Solid top only
48" X 84"	Solid top only
48" X 96"	Solid top only
48" X 108"	Solid top only

## **SPECIES**

RUSTIC CHERRY • RUSTIC WALNUT • WORMY MAPLE

## **SHAPE OPTIONS**



RECTANGLE

## **EDGE OPTIONS**



LIVE/MISSION

# LAPORTE BENCH

---

- 1½" Rectangle top with Live Edge standard
- Every Live edge top is unique and will vary from top to top
- Shown in Rustic Walnut with Natural finish  
(Note: Actual color may vary from picture)



## **SIZES**

---

12 ½" X 72"    Solid top only  
12 ½" X 84"    Solid top only

## **SPECIES**

---

RUSTIC CHERRY • RUSTIC WALNUT • WORMY MAPLE

## **SHAPE OPTIONS**

---



RECTANGLE

## **EDGE OPTIONS**

---



LIVE/MISSION





# LAURIE'S LEG

- 1" Rectangle top with Mission edge standard
- 4" straight skirt (No option on skirt size due to self store compartment)
- Not available in pub height
- 3" x 3" tapered legs stay stationary like trestle tables when top opens
- Floor to bottom of skirt 25"



## SIZES

42" X 60"	Up to 4-12" leaves	Stores up to 4 unskirted leaves
42" X 66"	Up to 4-12" leaves	Stores up to 4 unskirted leaves
48" X 60"	Up to 4-12" leaves	Stores up to 4 unskirted leaves
48" X 66"	Up to 4-12" leaves	Stores up to 4 unskirted leaves

## SPECIES

BROWN MAPLE • RED OAK • QSWO • CHERRY • HARD MAPLE • HICKORY • RUSTIC CHERRY • RUSTIC HICKORY • RUSTIC QSWO  
 RUSTIC WALNUT • SAP CHERRY • WALNUT • WORMY MAPLE • PLAIN SAWN WHITE OAK • RUSTIC PLAIN SAWN WHITE OAK

## SHAPE OPTIONS



RECTANGLE  
(STANDARD)



1" RADIUS  
CORNER



BOW END

## EDGE OPTIONS



MISSION  
(STANDARD)



5/8" ROUNDOVER



WATERFALL



BEVEL



CHAMFER

# LEXINGTON DOUBLE



- 1" Rectangle top with Mission edge standard
- Base standard as shown with levelers
- Quarter Sawn White Oak table will have regular White Oak base
- Floor to bottom of skirt 26½"
- Leaf table will have grain side to side
- Solid top will have grain lengthwise
- Shown in Sap Cherry with D22N08963 Sandstone stain, 48" X 120"  
*(Note: Actual color may vary from picture)*



## SIZES

42" X 96"	Up to 4-12" leaves	Stores up to 2 unskirted leaves
42" X 108"	Solid top only	
42" X 120"	Solid top only	
48" X 96"	Up to 4-12" leaves	Stores up to 2 unskirted leaves
48" X 108"	Solid top only	
48" X 120"	Solid top only	

## SPECIES

BROWN MAPLE • RED OAK • QSWO • CHERRY • HARD MAPLE • HICKORY • RUSTIC CHERRY • RUSTIC HICKORY • RUSTIC QSWO  
RUSTIC WALNUT • SAP CHERRY • WALNUT • WORMY MAPLE • PLAIN SAWN WHITE OAK • RUSTIC PLAIN SAWN WHITE OAK

## SHAPE OPTIONS



RECTANGLE  
(STANDARD)



1" RADIUS  
CORNER



BOW END

## EDGE OPTIONS



MISSION  
(STANDARD)



5/8" ROUNDOVER



WATERFALL



BEVEL



CHAMFER



## LEXINGTON DOUBLE

shown in Sap Cherry  
with D22N08963  
Sandstone stain,  
48" X 120". Shown with  
Artisan Lemont Chairs.

*(Note: Actual color  
may vary from picture)*







# LEXINGTON LEG MINI

- 1" Rectangle top with Mission edge standard
- 3" Twist legs standard as shown
- 2½" Straight skirt standard as shown
- Available in 36" height
- Floor to bottom of skirt 26½"
- Shown in Red Oak with PCL-183 Muted White 10 sheen top and PCL-182 Muted Black 10 sheen base  
(Note: Actual color may vary from picture)



## SIZES

36" X 42"	Up to 4-12" leaves	Self-store NOT available
36" X 48"	Up to 4-12" leaves	Stores up to 2 leaves, 1 w/skirts & 1 w/o
36" X 54"	Up to 4-12" leaves	Stores up to 2 leaves, 1 w/skirts & 1 w/o
42" X 42"	Up to 4-12" leaves	Self-store NOT available
42" X 48"	Up to 4-12" leaves	Self-store NOT available
42" X 54"	Up to 4-12" leaves	Stores up to 4 leaves, 2 w/skirts & 2 w/o

## SPECIES

BROWN MAPLE • RED OAK • QSWO • CHERRY • HARD MAPLE • HICKORY • RUSTIC CHERRY • RUSTIC HICKORY • RUSTIC QSWO  
RUSTIC WALNUT • SAP CHERRY • WALNUT • WORMY MAPLE • PLAIN SAWN WHITE OAK • RUSTIC PLAIN SAWN WHITE OAK

## SHAPE OPTIONS



RECTANGLE  
(STANDARD)



1" RADIUS  
CORNER



BOW END

## EDGE OPTIONS



MISSION  
(STANDARD)



5/8" ROUNDOVER



WATERFALL



BEVEL



CHAMFER

# LEXINGTON BENCH

- 1" Rectangle top with Mission edge standard
- 18" high
- Leaf storage box to store all 4 leaves
- Solid tops will not have center legs
- Fabric or Leather bench top available – solid top only. See page 32 for details.
- Shown in Brown Maple with FC-15743 Briar top & FC-11434 Driftwood base  
*(Note: Actual color may vary from picture)*



## SIZES

- |             |                                 |
|-------------|---------------------------------|
| 12 ½" X 48" | Solid top or up to 4-12" leaves |
| 12 ½" X 60" | Solid top or up to 4-12" leaves |
| 12 ½" X 72" | Solid top or up to 4-12" leaves |

## SPECIES

BROWN MAPLE • RED OAK • QSWO • CHERRY • HARD MAPLE • HICKORY • RUSTIC CHERRY • RUSTIC HICKORY • RUSTIC QSWO  
RUSTIC WALNUT • SAP CHERRY • WALNUT • WORMY MAPLE • PLAIN SAWN WHITE OAK • RUSTIC PLAIN SAWN WHITE OAK

## SHAPE OPTIONS



RECTANGLE

## EDGE OPTIONS



MISSION





# LEXINGTON LEG



42" X 72" 30" high  
2-12" S/S leaves  
Brown Maple or  
Rustic Hickory  
Standard shape & edge

- 1" Rectangle top with Mission edge standard
- 3½" Twist legs standard as shown
- 3½" Straight skirt standard as shown
- Floor to bottom of skirt 25½"
- Available in 36" height
- Recommended chair: Lawson from Artisan Chairs
- Shown in Brown Maple with FC-15743 Briar top and FC-11434 Driftwood base  
*(Note: Actual color may vary from picture)*



## SIZES

42" X 60"	Up to 4-12" leaves	Stores up to 4 leaves, 2 w/skirts & 2 w/o
42" X 66"	Up to 4-12" leaves	Stores up to 4 leaves, 2 w/skirts & 2 w/o
42" X 72"	Up to 4-12" leaves	Stores up to 4 leaves, 2 w/skirts & 2 w/o
48" X 60"	Up to 4-12" leaves	Stores up to 4 leaves, 2 w/skirts & 2 w/o
48" X 66"	Up to 4-12" leaves	Stores up to 4 leaves, 2 w/skirts & 2 w/o
48" X 72"	Up to 4-12" leaves	Stores up to 4 leaves, 2 w/skirts & 2 w/o

Available 84" long, N/A with butterfly leaves. See pricelist for details.

For more than 4 leaves, see page 33

## SPECIES

BROWN MAPLE • RED OAK • QSWO • CHERRY • HARD MAPLE • HICKORY • RUSTIC CHERRY • RUSTIC HICKORY • RUSTIC QSWO  
RUSTIC WALNUT • SAP CHERRY • WALNUT • WORMY MAPLE • PLAIN SAWN WHITE OAK • RUSTIC PLAIN SAWN WHITE OAK

## SHAPE OPTIONS



RECTANGLE  
(STANDARD)



1" RADIUS  
CORNER



BOW END

## EDGE OPTIONS



MISSION  
(STANDARD)



5/8" ROUND  
OVER



WATERFALL



BEVEL



CHAMFER



## LEXINGTON LEG

shown in Brown Maple with  
FC-47823 Bel Air top & FC-230  
Onyx base. Shown with Artisan  
Lawson Chairs.

*(Note: Actual color may vary from picture)*



# LEXINGTON SINGLE MINI

- 1" Round top with Mission edge standard
- Base standard as shown with levelers
- Quarter Sawn White Oak table will have regular White Oak base
- Available in 36" height
- Floor to bottom of skirt 26½"
- Shown in Red Oak with PCL-185 Weathered Hazelnut 10 sheen top, PCL-184 Weathered Greek Vanilla 10 sheen base  
*(Note: Actual color may vary from picture)*



## SIZES

- 36" X 46" Round    Up to 2-12" leaves
- 42" X 42" Round    Up to 2-12" leaves

## SPECIES

BROWN MAPLE • RED OAK • QSWO • CHERRY • HARD MAPLE • HICKORY • RUSTIC CHERRY • RUSTIC HICKORY • RUSTIC QSWO  
RUSTIC WALNUT • SAP CHERRY • WALNUT • WORMY MAPLE • PLAIN SAWN WHITE OAK • RUSTIC PLAIN SAWN WHITE OAK

## SHAPE OPTIONS



ROUND

## EDGE OPTIONS



MISSION  
(STANDARD)



5/8" ROUNDOVER



WATERFALL



BEVEL



CHAMFER



# LEXINGTON SINGLE



54" X 54" 30" high  
2-12" leaves  
Brown Maple  
Standard shape & edge

- 1" Round top with Mission edge standard
- Base standard as shown with levelers
- Quarter Sawn White Oak table will have regular White Oak base
- Floor to bottom of skirt 26½"
- Available in 36" height
- Shown in Brown Maple with FC-42000 Almond 10 sheen top, SP-168 Weathered Beige 10 sheen base  
(Note: Actual color may vary from picture)



## SIZES

48" X 48" Round	Up to 2-12" leaves or 1-18" butterfly leaf
54" X 54" Round	Up to 2-12" leaves or 1-18" butterfly leaf
60" X 60" Round	Up to 2-12" leaves
72" X 72" Round	Solid top only

## SPECIES

BROWN MAPLE • RED OAK • QSWO • CHERRY • HARD MAPLE • HICKORY • RUSTIC CHERRY • RUSTIC HICKORY • RUSTIC QSWO  
RUSTIC WALNUT • SAP CHERRY • WALNUT • WORMY MAPLE • PLAIN SAWN WHITE OAK • RUSTIC PLAIN SAWN WHITE OAK

## SHAPE OPTIONS



ROUND

## EDGE OPTIONS



MISSION  
(STANDARD)



5/8" ROUNDOVER



WATERFALL



BEVEL



CHAMFER



## LEXINGTON SINGLE

shown in Quarter Sawn  
White Oak with FC-924  
Michaels Cherry stain.  
Shown with Artisan  
Lemont Chairs.

*(Note: Actual color may vary  
from picture)*









# LEXINGTON TRESTLE

- 1" Rectangle top with Mission edge standard
- Base standard as shown with levelers
- Floor to bottom of skirt 26½"
- Available in 36" height
- Recommended chair: Lawson from Artisan Chairs
- Shown in Rustic Cherry with FC-9018 Lite Asbury 10 sheen finish  
*(Note: Actual color may vary from picture)*



## SIZES

42" X 60"	Up to 4-12" leaves or 1-18" butterfly leaf	Stores up to 4 unskirted leaves
42" X 66"	Up to 4-12" leaves or up to 2-18" butterfly leaves	Stores up to 4 leaves, 2 w/skirts & 2 w/o
42" X 72"	Up to 4-12" leaves or up to 2-18" butterfly leaves	Stores up to 4 leaves, 2 w/skirts & 2 w/o
48" X 60"	Up to 4-12" leaves or 1-18" butterfly leaf	Stores up to 4 leaves, 2 w/skirts & 2 w/o
48" X 66"	Up to 4-12" leaves or up to 2-18" butterfly leaves	Stores up to 4 unskirted leaves
48" X 72"	Up to 4-12" leaves or up to 2-18" butterfly leaves	Stores up to 4 unskirted leaves

*Available 84" long, N/A with butterfly leaves. See pricelist for details.*

*For more than 4 leaves, see page 33*

## SPECIES

BROWN MAPLE • RED OAK • QSWO • CHERRY • HARD MAPLE • HICKORY • RUSTIC CHERRY • RUSTIC HICKORY • RUSTIC QSWO  
RUSTIC WALNUT • SAP CHERRY • WALNUT • WORMY MAPLE • PLAIN SAWN WHITE OAK • RUSTIC PLAIN SAWN WHITE OAK

## SHAPE OPTIONS



*Changing the top shape may affect self-store ability*

## EDGE OPTIONS



# LEXINGTON CABINET

- 1" Rectangle top with Mission edge standard
- Standard with 1-18" Butterfly Leaf
- Cabinet base size is 26" x 26" (no options)
- 36" high standard. Also available in 30" & 42" high (30" h only has 2 drawers)
- Side mount drawer slides
- K2040-SN hardware standard
- Floor to bottom of skirt 32½"
- Not available with Round top
- Shown in Brown Maple with FC-17882 Vintage Antique top & FC-230 Onyx base (Note: Actual color may vary from picture)



## SIZES

42" X 42"	Solid top, 1-12" leaf, or 1-18" butterfly leaf
42" X 48"	Solid top, 1-12" leaf, or 1-18" butterfly leaf
42" X 54"	Solid top, 1-12" leaf, or 1-18" butterfly leaf
48" X 48"	Solid top, 1-12" leaf, or 1-18" butterfly leaf
48" X 54"	Solid top, 1-12" leaf, or 1-18" butterfly leaf

## SPECIES

BROWN MAPLE • RED OAK • QSWO • CHERRY • HARD MAPLE • HICKORY • RUSTIC CHERRY • RUSTIC HICKORY • RUSTIC QSWO  
RUSTIC WALNUT • SAP CHERRY • WALNUT • WORMY MAPLE • PLAIN SAWN WHITE OAK • RUSTIC PLAIN SAWN WHITE OAK

## SHAPE OPTIONS



RECTANGLE  
(STANDARD)



1" RADIUS  
CORNER



BOW END

## EDGE OPTIONS



MISSION  
(STANDARD)



5/8" ROUNDOVER



WATERFALL



BEVEL



CHAMFER



# LIVE EDGE TABLE



42" X 84" 30" high  
Solid Top  
Rustic Walnut  
Choose any base

- 1½" Rectangle top with Live edge standard
- Black powder coated metal base
- Base standard as shown with levelers
- 30" high standard. Also available in 36" high
- Every Live edge top is unique and will vary from top to top
- For pricing, see page 5 of pricelist



Live Edge top with Xavier Trestle base



EL DORADO BASE



LIFESTYLE BASE



MARTIN BASE



PAGOSA BASE



XAVIER BASE

## SIZES

36" X 60"	42" X 60"	48" X 60"
36" X 72"	42" X 72"	48" X 72"
36" X 84"	42" X 84"	48" X 84"
36" X 96"	42" X 96"	48" X 96"
36" X 108"	42" X 108"	48" X 108"
36" X 120"	42" X 120"	48" X 120"

## SPECIES

RUSTIC CHERRY  
RUSTIC WALNUT  
WORMY MAPLE

## SHAPE OPTIONS



RECTANGLE



LIVE/MISSION



# LIVE EDGE BENCH

- 1½" Rectangle top with Live edge standard
- Black powder coated metal base
- 18" high standard. NOT available in 24" high
- Every Live edge top is unique and will vary from top to top
- For pricing, see page 5 of pricelist



12 ½" X 84"  
Solid Top  
Rustic Walnut  
Choose any base



Live Edge top  
with Xavier  
Bench base



EL DORADO BASE



LIFESTYLE BASE



PAGOSA BASE



XAVIER BASE

## SIZES

12 ½" X 60"  
12 ½" X 72"  
12 ½" X 84"  
12 ½" X 96"

## SPECIES

RUSTIC CHERRY  
RUSTIC WALNUT  
WORMY MAPLE

## SHAPE OPTIONS



RECTANGLE

## EDGE OPTIONS



LIVE/MISSION



LIVE EDGE  
TABLE w/  
XAVIER BASE

shown in Rustic Walnut  
with FC-47823 Bel Air  
stain. Shown with FN  
Sheldon Chairs.

*(Note: Actual color  
may vary from picture)*









# LIVE EDGE ROUGH SAWN TABLE

- 1¾" Rectangle top with Live edge standard
- Black powder coated metal base
- Base standard as shown with levelers
- 30" high standard. Also available in 36" high
- Every Live edge top is unique and will vary from top to top
- For pricing, see page 5 of pricelist



Live Edge  
Rough Sawn top  
with El Dorado  
Trestle base



EL DORADO BASE



LIFESTYLE BASE



MARTIN BASE



PAGOSA BASE



XAVIER BASE

## SIZES

36" X 60"	42" X 60"	48" X 60"
36" X 72"	42" X 72"	48" X 72"
36" X 84"	42" X 84"	48" X 84"
36" X 96"	42" X 96"	48" X 96"

## SPECIES

ROUGH SAWN WORMY MAPLE

## SHAPE OPTIONS



RECTANGLE

## EDGE OPTIONS



LIVE/MISSION

# LIVE EDGE ROUGH SAWN BENCH

- 1¾" Rectangle top with Live edge standard
- Black powder coated metal base
- 18" high standard. NOT available in 24" high
- Every Live edge top is unique and will vary from top to top
- For pricing, see page 5 of pricelist



Live Edge  
Rough Sawn top  
with El Dorado  
Bench base



EL DORADO BASE



LIFESTYLE BASE



PAGOSA BASE



XAVIER BASE

## SIZES

- 12 ½" X 60"
- 12 ½" X 72"
- 12 ½" X 84"
- 12 ½" X 96"

## SPECIES

ROUGH SAWN WORMY MAPLE

## SHAPE OPTIONS



RECTANGLE

## EDGE OPTIONS



LIVE/MISSION



LIVE EDGE  
ROUGH SAWN  
TABLE w/  
EL DORADO  
BASE

shown in Rough Sawn  
Wormy Maple with  
FC-47823 Bel Air 10  
sheen finish. Shown with  
West Point Live Edge  
Rough Sawn Bench w/  
El Dorado Base and FN  
Denver Chairs.

*(Note: Actual color  
may vary from picture)*









# LIVINGSTON TABLE

- 1½" Rectangle top with Mission edge standard
- Black powder coated metal base
- Base standard as shown with levelers
- 30" high standard. Also available in 36" high
- For pricing, see page 5 of pricelist



Livingston top with Lifestyle Trestle base



EL DORADO BASE



LIFESTYLE BASE



MARTIN BASE



PAGOSA BASE



XAVIER BASE

## SIZES

36" X 60"	42" X 60"	48" X 60"
36" X 72"	42" X 72"	48" X 72"
36" X 84"	42" X 84"	48" X 84"
36" X 96"	42" X 96"	48" X 96"
36" X 108"	42" X 108"	48" X 108"
36" X 120"	42" X 120"	48" X 120"

## SPECIES

BROWN MAPLE • RED OAK • QSWO • CHERRY • HARD MAPLE  
 HICKORY • RUSTIC CHERRY • RUSTIC HICKORY • RUSTIC QSWO  
 RUSTIC WALNUT • SAP CHERRY • WALNUT • WORMY MAPLE  
 PLAIN SAWN WHITE OAK • RUSTIC PLAIN SAWN WHITE OAK

## SHAPE OPTIONS



RECTANGLE

## EDGE OPTIONS



MISSION

# LIVINGSTON BENCH

- 1½" Rectangle top with Mission edge standard
- Black powder coated metal base
- 18" high standard. NOT available in 24" high
- For pricing, see page 5 of pricelist



Livingston top with Lifestyle Bench base



EL DORADO BASE



LIFESTYLE BASE



PAGOSA BASE



XAVIER BASE

## SIZES

- 12 ½" X 60"
- 12 ½" X 72"
- 12 ½" X 84"
- 12 ½" X 96"

## SPECIES

- BROWN MAPLE • RED OAK • QSWO • CHERRY • HARD MAPLE
- HICKORY • RUSTIC CHERRY • RUSTIC HICKORY • RUSTIC QSWO
- RUSTIC WALNUT • SAP CHERRY • WALNUT • WORMY MAPLE
- PLAIN SAWN WHITE OAK • RUSTIC PLAIN SAWN WHITE OAK

## SHAPE OPTIONS



RECTANGLE

## EDGE OPTIONS



MISSION





# LOGAN TRESTLE

- 1" Rectangle top with Mission edge standard
- Base standard as shown with levelers
- Available in 36" height
- Floor to bottom of skirt 26½"
- Shown in Red Oak with FC-10944 Tavern stain  
(Note: Actual color may vary from picture)



## SIZES

36" X 48"	Up to 3-12" leaves	Stores up to 2 unskirted leaves
36" X 54"	Up to 3-12" leaves	Stores up to 2 unskirted leaves
36" X 60"	Up to 3-12" leaves	Stores up to 2 unskirted leaves
42" X 48"	Up to 3-12" leaves	Self-store NOT available
42" X 54"	Up to 3-12" leaves	Stores up to 3 unskirted leaves
42" X 60"	Up to 3-12" leaves	Stores up to 3 unskirted leaves

## SPECIES

BROWN MAPLE • RED OAK • QSWO • CHERRY • HARD MAPLE • HICKORY • RUSTIC CHERRY • RUSTIC HICKORY • RUSTIC QSWO  
RUSTIC WALNUT • SAP CHERRY • WALNUT • WORMY MAPLE • PLAIN SAWN WHITE OAK • RUSTIC PLAIN SAWN WHITE OAK

## SHAPE OPTIONS



## EDGE OPTIONS



# LOGAN BENCH

- 1" Rectangle top with Mission edge standard
- 18" high
- Leaf storage box to store all 3 leaves
- Solid tops will not have center legs
- Fabric or Leather bench top available – solid top only. See page 32 for details.
- Shown in Red Oak with FC-42000 Almond stain  
(Note: Actual color may vary from picture)



## SIZES

12 ½" X 48"	Solid top or up to 3-12" leaves
12 ½" X 54"	Solid top or up to 3-12" leaves
12 ½" X 60"	Solid top or up to 3-12" leaves

## SPECIES

BROWN MAPLE • RED OAK • QSWO • CHERRY • HARD MAPLE • HICKORY • RUSTIC CHERRY • RUSTIC HICKORY • RUSTIC QSWO  
RUSTIC WALNUT • SAP CHERRY • WALNUT • WORMY MAPLE • PLAIN SAWN WHITE OAK • RUSTIC PLAIN SAWN WHITE OAK

## SHAPE OPTIONS



RECTANGLE

## EDGE OPTIONS



MISSION

# MADISON LEG PUB

- 1" Square top with Mission edge standard
- Arched skirt standard as shown
- 3" x 3" straight legs standard
- Floor to bottom of skirt 30½" at the legs and 32½" at the center
- 36" high standard. Also available in 30" & 42" h



## SIZES

- |                  |  |
|------------------|--|
| 36" X 36" Square | Up to 3-12" leaves                         |
| 42" X 42" Square | Up to 3-12" leaves or 1-18" butterfly leaf |
| 48" X 48" Square | Up to 3-12" leaves or 1-18" butterfly leaf |

## SPECIES

BROWN MAPLE • RED OAK • QSWO • CHERRY • HARD MAPLE • HICKORY • RUSTIC CHERRY • RUSTIC HICKORY • RUSTIC QSWO  
RUSTIC WALNUT • SAP CHERRY • WALNUT • WORMY MAPLE • PLAIN SAWN WHITE OAK • RUSTIC PLAIN SAWN WHITE OAK

## SHAPE OPTIONS



RECTANGLE  
(STANDARD)



1" RADIUS  
CORNER

## EDGE OPTIONS



MISSION  
(STANDARD)



5/8" ROUNDOVER



WATERFALL



BEVEL



CHAMFER



# MANKATO TRESTLE

- 1" Rectangle top with Mission edge standard
- Base standard as shown with levelers
- Available in 36" height
- Floor to bottom of skirt 26½"
- Shown in Red Oak with FC-15743 Briar finish  
*(Note: Actual color may vary from picture)*



## SIZES

42" X 60"	Up to 4-12" leaves	Stores up to 4 unskirted leaves
42" X 66"	Up to 4-12" leaves	Stores up to 4 leaves, 2 w/skirts & 2 w/o
42" X 72"	Up to 4-12" leaves	Stores up to 4 leaves, 2 w/skirts & 2 w/o
48" X 60"	Up to 4-12" leaves	Stores up to 4 leaves, 2 w/skirts & 2 w/o
48" X 66"	Up to 4-12" leaves	Stores up to 4 unskirted leaves
48" X 72"	Up to 4-12" leaves	Stores up to 4 unskirted leaves

Available 84" long, N/A with butterfly leaves. See pricelist for details.

For more than 4 leaves, see page 33

## SPECIES

BROWN MAPLE • RED OAK • QSWO • CHERRY • HARD MAPLE • HICKORY • RUSTIC CHERRY • RUSTIC HICKORY • RUSTIC QSWO  
RUSTIC WALNUT • SAP CHERRY • WALNUT • WORMY MAPLE • PLAIN SAWN WHITE OAK • RUSTIC PLAIN SAWN WHITE OAK

## SHAPE OPTIONS



Changing the top shape may affect self-store ability

## EDGE OPTIONS



# MANKATO TRESTLE

shown in Rustic  
Hickory with  
D22N08963

Sandstone stain.

Shown with Artisan  
Vonda Chairs.

*(Note: Actual color  
may vary from picture)*









# MANKATO BENCH

- 1 ¼" Rectangle top with Mission edge
- 18" high



## **SIZES**

- |             |                |
|-------------|----------------|
| 12 ½" X 48" | Solid top only |
| 12 ½" X 60" | Solid top only |
| 12 ½" X 72" | Solid top only |

## **SPECIES**

BROWN MAPLE • RED OAK • QSWO • CHERRY • HARD MAPLE • HICKORY • RUSTIC CHERRY • RUSTIC HICKORY • RUSTIC QSWO  
RUSTIC WALNUT • SAP CHERRY • WALNUT • WORMY MAPLE • PLAIN SAWN WHITE OAK • RUSTIC PLAIN SAWN WHITE OAK

## **SHAPE OPTIONS**



RECTANGLE

## **EDGE OPTIONS**



MISSION

# MANSFIELD LEG

- 1" Boat shape top with Bevel edge standard
- 2 ½" straight skirt
- 3" x 3" leg as shown
- Available in 36" height
- Floor to bottom of skirt 26½"
- Shown in Brown Maple with FC-7992 Asbury Brown stain (*Note: Actual color may vary from picture*)



## SIZES

42" X 60"	Up to 4-12" leaves or 1-18" butterfly leaf	Stores up to 2 leaves, 1 w/skirts & 1 w/o
42" X 66"	Up to 4-12" leaves or 1-18" butterfly leaf	Stores up to 2 leaves, 1 w/skirts & 1 w/o
42" X 72"	Up to 4-12" leaves or 1-18" butterfly leaf	Stores up to 4 leaves, 2 w/skirts & 2 w/o
48" X 60"	Up to 4-12" leaves or 1-18" butterfly leaf	Stores up to 2 leaves, 1 w/skirts & 1 w/o
48" X 66"	Up to 4-12" leaves or 1-18" butterfly leaf	Stores up to 2 leaves, 1 w/skirts & 1 w/o
48" X 72"	Up to 4-12" leaves or 1-18" butterfly leaf	Stores up to 4 leaves, 2 w/skirts & 2 w/o

Available 84" long, N/A with butterfly leaves. See pricelist for details.

For more than 4 leaves, see page 33

## SPECIES

BROWN MAPLE • RED OAK • QSWO • CHERRY • HARD MAPLE • HICKORY • RUSTIC CHERRY • RUSTIC HICKORY • RUSTIC QSWO  
RUSTIC WALNUT • SAP CHERRY • WALNUT • WORMY MAPLE • PLAIN SAWN WHITE OAK • RUSTIC PLAIN SAWN WHITE OAK

## SHAPE OPTIONS

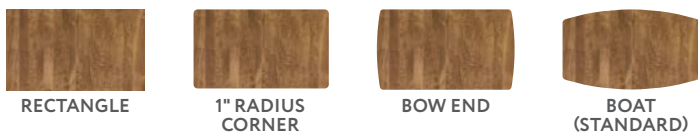

Changing the top shape may affect self-store ability

## EDGE OPTIONS



# McCoy TRESTLE

- 1" Rectangle top with 1" radius corner with Bevel edge standard
- Trestle base is 23 1/2" wide at top & 28" wide at bottom
- Floor to bottom of skirt 26 1/2"
- Available in 36" height



## SIZES

42" X 60"	Up to 4-12" leaves or 1-18" butterfly leaf	Stores up to 4 unskirted leaves
42" X 66"	Up to 4-12" leaves or up to 2-18" butterfly leaves	Stores up to 4 leaves, 2 w/skirts & 2 w/o
42" X 72"	Up to 4-12" leaves or up to 2-18" butterfly leaves	Stores up to 4 leaves, 2 w/skirts & 2 w/o
48" X 60"	Up to 4-12" leaves or 1-18" butterfly leaf	Stores up to 4 leaves, 2 w/skirts & 2 w/o
48" X 66"	Up to 4-12" leaves or up to 2-18" butterfly leaves	Stores up to 4 unskirted leaves
48" X 72"	Up to 4-12" leaves or up to 2-18" butterfly leaves	Stores up to 4 unskirted leaves

Available 84" long, N/A with butterfly leaves. See pricelist for details.

For more than 4 leaves, see page 33

## SPECIES

BROWN MAPLE • RED OAK • QSWO • CHERRY • HARD MAPLE • HICKORY • RUSTIC CHERRY • RUSTIC HICKORY • RUSTIC QSWO  
RUSTIC WALNUT • SAP CHERRY • WALNUT • WORMY MAPLE • PLAIN SAWN WHITE OAK • RUSTIC PLAIN SAWN WHITE OAK

## SHAPE OPTIONS



Changing the top shape may affect self-store ability

## EDGE OPTIONS





# McCoy BENCH

- 1" Rectangle top with Mission edge standard
- 18" high
- Leaf storage box to store all 4 leaves
- Solid tops will not have center legs
- Fabric or Leather bench top available – solid top only. See page 32 for details.



## **SIZES**

12 ½" X 48"	Solid top or up to 4-12" leaves
12 ½" X 60"	Solid top or up to 4-12" leaves
12 ½" X 72"	Solid top or up to 4-12" leaves

## **SPECIES**

BROWN MAPLE • RED OAK • QSWO • CHERRY • HARD MAPLE • HICKORY • RUSTIC CHERRY • RUSTIC HICKORY • RUSTIC QSWO  
RUSTIC WALNUT • SAP CHERRY • WALNUT • WORMY MAPLE • PLAIN SAWN WHITE OAK • RUSTIC PLAIN SAWN WHITE OAK

## **SHAPE OPTIONS**



RECTANGLE

## **EDGE OPTIONS**



MISSION



# MISSION LEG

- 1" Rectangle top with Mission edge standard
- 3" x 3" Legs with corbels standard
- 2 ½" straight skirt standard
- Floor to bottom of skirt 26½"
- Available in 36" height



## SIZES

42" X 60"	Up to 4-12" leaves or 1-18" butterfly leaf	Stores up to 4 leaves, 2 w/skirts & 2 w/o
42" X 66"	Up to 4-12" leaves or 1-18" butterfly leaf	Stores up to 4 leaves, 2 w/skirts & 2 w/o
42" X 72"	Up to 4-12" leaves or 1-18" butterfly leaf	Stores up to 4 leaves, 2 w/skirts & 2 w/o
48" X 60"	Up to 4-12" leaves or 1-18" butterfly leaf	Stores up to 4 leaves, 2 w/skirts & 2 w/o
48" X 66"	Up to 4-12" leaves or 1-18" butterfly leaf	Stores up to 4 leaves, 2 w/skirts & 2 w/o
48" X 72"	Up to 4-12" leaves or 1-18" butterfly leaf	Stores up to 4 leaves, 2 w/skirts & 2 w/o

Available 84" long, N/A with butterfly leaves. See pricelist for details.

For more than 4 leaves, see page 33

## SPECIES

BROWN MAPLE • RED OAK • QSWO • CHERRY • HARD MAPLE • HICKORY • RUSTIC CHERRY • RUSTIC HICKORY • RUSTIC QSWO  
RUSTIC WALNUT • SAP CHERRY • WALNUT • WORMY MAPLE • PLAIN SAWN WHITE OAK • RUSTIC PLAIN SAWN WHITE OAK

## SHAPE OPTIONS

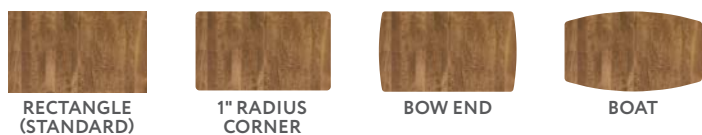

Changing the top shape may affect self-store ability

## EDGE OPTIONS



# MISSION TRESTLE

- 1" Rectangle top with Mission edge standard
- 2 ½" straight skirts with corner blocks
- Trestle base is 22" wide
- Floor to bottom of skirt 26½"
- Available in 36" height



## SIZES

42" X 60"	Up to 4-12" leaves or 1-18" butterfly leaf	Stores up to 4 unskirted leaves
42" X 66"	Up to 4-12" leaves or up to 2-18" butterfly leaves	Stores up to 4 leaves, 2 w/skirts & 2 w/o
42" X 72"	Up to 4-12" leaves or up to 2-18" butterfly leaves	Stores up to 4 leaves, 2 w/skirts & 2 w/o
48" X 60"	Up to 4-12" leaves or 1-18" butterfly leaf	Stores up to 4 leaves, 2 w/skirts & 2 w/o
48" X 66"	Up to 4-12" leaves or up to 2-18" butterfly leaves	Stores up to 4 unskirted leaves
48" X 72"	Up to 4-12" leaves or up to 2-18" butterfly leaves	Stores up to 4 unskirted leaves

Available 84" long, N/A with butterfly leaves. See pricelist for details.

For more than 4 leaves, see page 33

## SPECIES

BROWN MAPLE • RED OAK • QSWO • CHERRY • HARD MAPLE • HICKORY • RUSTIC CHERRY • RUSTIC HICKORY • RUSTIC QSWO  
 RUSTIC WALNUT • SAP CHERRY • WALNUT • WORMY MAPLE • PLAIN SAWN WHITE OAK • RUSTIC PLAIN SAWN WHITE OAK

## SHAPE OPTIONS



RECTANGLE  
(STANDARD)

1" RADIUS  
CORNER

BOW END

## EDGE OPTIONS



MISSION  
(STANDARD)

5/8" ROUNDOVER

WATERFALL

BEVEL

CHAMFER





# MISSION BENCH

- 1" Rectangle top with Mission edge standard
- 18" high
- Includes leaf storage box that stores all 4 leaves
- Solid tops will not have center legs
- Fabric or Leather bench top available – solid top only. See page 32 for details.



## **SIZES**

12 ½" X 48"	Solid top or up to 4-12" leaves
12 ½" X 60"	Solid top or up to 4-12" leaves
12 ½" X 72"	Solid top or up to 4-12" leaves

## **SPECIES**

BROWN MAPLE • RED OAK • QSWO • CHERRY • HARD MAPLE • HICKORY • RUSTIC CHERRY • RUSTIC HICKORY • RUSTIC QSWO  
RUSTIC WALNUT • SAP CHERRY • WALNUT • WORMY MAPLE • PLAIN SAWN WHITE OAK • RUSTIC PLAIN SAWN WHITE OAK

## **SHAPE OPTIONS**



RECTANGLE

## **EDGE OPTIONS**



MISSION

# MONARCH CABINET



- 1" Rectangle top with Mission edge standard
- Base standard as shown with levelers
- Cabinet base size is 25" x 25" (no options)
- 36" high standard. Also available in 30" & 42" high (30" h only has 2 drawers)
- Side mount drawer slides
- K2040-BL hardware standard
- Floor to bottom of skirt 32½"
- Not available with Round top
- Shown in Red Oak with D22N08963 Sandstone stain  
*(Note: Actual color may vary from picture)*



## SIZES

- 42" X 42" Solid top, 1-12" leaf, or 1-18" butterfly leaf
- 42" X 48" Solid top, 1-12" leaf, or 1-18" butterfly leaf
- 42" X 54" Solid top, 1-12" leaf, or 1-18" butterfly leaf
- 48" X 48" Solid top, 1-12" leaf, or 1-18" butterfly leaf
- 48" X 54" Solid top, 1-12" leaf, or 1-18" butterfly leaf

## SPECIES

BROWN MAPLE • RED OAK • QSWO • CHERRY • HARD MAPLE • HICKORY • RUSTIC CHERRY • RUSTIC HICKORY • RUSTIC QSWO  
RUSTIC WALNUT • SAP CHERRY • WALNUT • WORMY MAPLE • PLAIN SAWN WHITE OAK • RUSTIC PLAIN SAWN WHITE OAK

## SHAPE OPTIONS



RECTANGLE  
(STANDARD)



1" RADIUS  
CORNER



BOW END

## EDGE OPTIONS



MISSION  
(STANDARD)



5/8" ROUNDOVER



WATERFALL



BEVEL



CHAMFER



# NAPERVILLE TRESTLE

- 1" Bow End top with Waterfall edge standard
- Base standard as shown with levelers
- Floor to bottom of skirt 26½"
- Available in 36" height
- Recommended chair: Naperville from Artisan Chairs
- Shown in Quarter Sawn White Oak with Michaels Cherry stain (Note: Actual color may vary from picture)



## SIZES

42" X 60"	Up to 4-12" leaves or 1-18" butterfly leaf	Stores up to 4 unskirted leaves
42" X 66"	Up to 4-12" leaves or up to 2-18" butterfly leaves	Stores up to 4 leaves, 2 w/skirts & 2 w/o
42" X 72"	Up to 4-12" leaves or up to 2-18" butterfly leaves	Stores up to 4 leaves, 2 w/skirts & 2 w/o
48" X 60"	Up to 4-12" leaves or 1-18" butterfly leaf	Stores up to 4 leaves, 2 w/skirts & 2 w/o
48" X 66"	Up to 4-12" leaves or up to 2-18" butterfly leaves	Stores up to 4 unskirted leaves
48" X 72"	Up to 4-12" leaves or up to 2-18" butterfly leaves	Stores up to 4 unskirted leaves

Available 84" long, N/A with butterfly leaves. See pricelist for details.

For more than 4 leaves, see page 33

## SPECIES

BROWN MAPLE • RED OAK • QSWO • CHERRY • HARD MAPLE • HICKORY • RUSTIC CHERRY • RUSTIC HICKORY • RUSTIC QSWO  
 RUSTIC WALNUT • SAP CHERRY • WALNUT • WORMY MAPLE • PLAIN SAWN WHITE OAK • RUSTIC PLAIN SAWN WHITE OAK

## SHAPE OPTIONS



Changing the top shape may affect self-store ability

## EDGE OPTIONS





# NASHVILLE TRESTLE

- 1" Bow End top with Waterfall edge standard
- Base standard as shown with levelers
- Floor to bottom of skirt 26½"
- Available in 36" height
- Shown in Brown Maple with FC-40592 Earthtone stain (*Note: Actual color may vary from picture*)



## SIZES

42" X 60"	Up to 4-12" leaves or 1-18" butterfly leaf	Stores up to 4 unskirted leaves
42" X 66"	Up to 4-12" leaves or up to 2-18" butterfly leaves	Stores up to 4 leaves, 2 w/skirts & 2 w/o
42" X 72"	Up to 4-12" leaves or up to 2-18" butterfly leaves	Stores up to 4 leaves, 2 w/skirts & 2 w/o
48" X 60"	Up to 4-12" leaves or 1-18" butterfly leaf	Stores up to 4 leaves, 2 w/skirts & 2 w/o
48" X 66"	Up to 4-12" leaves or up to 2-18" butterfly leaves	Stores up to 4 unskirted leaves
48" X 72"	Up to 4-12" leaves or up to 2-18" butterfly leaves	Stores up to 4 unskirted leaves

Available 84" long, N/A with butterfly leaves. See pricelist for details.

For more than 4 leaves, see page 33

## SPECIES

BROWN MAPLE • RED OAK • QSWO • CHERRY • HARD MAPLE • HICKORY • RUSTIC CHERRY • RUSTIC HICKORY • RUSTIC QSWO  
RUSTIC WALNUT • SAP CHERRY • WALNUT • WORMY MAPLE • PLAIN SAWN WHITE OAK • RUSTIC PLAIN SAWN WHITE OAK

## SHAPE OPTIONS



Changing the top shape may affect self-store ability

## EDGE OPTIONS



# NASHVILLE BENCH

- 1" Rectangle top with Mission edge standard
- 18" high
- Leaf storage box to store all 4 leaves
- Solid tops will not have center legs
- Fabric or Leather bench top available – solid top only. See page 32 for details.
- Shown in Rustic Hickory with FC-42000 Almond stain (*Note: Actual color may vary from picture*)



## SIZES

12 ½" X 48"	Solid top or up to 4-12" leaves
12 ½" X 60"	Solid top or up to 4-12" leaves
12 ½" X 72"	Solid top or up to 4-12" leaves

## SPECIES

BROWN MAPLE • RED OAK • QSWO • CHERRY • HARD MAPLE • HICKORY • RUSTIC CHERRY • RUSTIC HICKORY • RUSTIC QSWO  
RUSTIC WALNUT • SAP CHERRY • WALNUT • WORMY MAPLE • PLAIN SAWN WHITE OAK • RUSTIC PLAIN SAWN WHITE OAK

## SHAPE OPTIONS



RECTANGLE

## EDGE OPTIONS



MISSION

# NEWARK LEG



- 1" Rectangle top with 3" radius corners and Mission edge standard
- Legs standard as shown
- No gap cover (not available)
- Floor to bottom of skirt 26"
- Available in 36" height
- Shown in Brown Maple with D22N08963 Sandstone stain  
(Note: Actual color may vary from picture)



## SIZES

42" X 60"	Up to 4-12" leaves	Stores up to 4 leaves, 2 w/skirts & 2 w/o
42" X 66"	Up to 4-12" leaves	Stores up to 4 leaves, 2 w/skirts & 2 w/o
42" X 72"	Up to 4-12" leaves	Stores up to 4 leaves, 2 w/skirts & 2 w/o
48" X 60"	Up to 4-12" leaves	Stores up to 4 leaves, 2 w/skirts & 2 w/o
48" X 66"	Up to 4-12" leaves	Stores up to 4 leaves, 2 w/skirts & 2 w/o
48" X 72"	Up to 4-12" leaves	Stores up to 4 leaves, 2 w/skirts & 2 w/o

Available 84" long, N/A with butterfly leaves. See pricelist for details.

For more than 4 leaves, see page 33

## SPECIES

BROWN MAPLE • RED OAK • QSWO • CHERRY • HARD MAPLE • HICKORY • RUSTIC CHERRY • RUSTIC HICKORY • RUSTIC QSWO  
RUSTIC WALNUT • SAP CHERRY • WALNUT • WORMY MAPLE • PLAIN SAWN WHITE OAK • RUSTIC PLAIN SAWN WHITE OAK

## SHAPE OPTIONS



3" RADIUS CORNER

## EDGE OPTIONS



MISSION (STANDARD)



5/8" ROUNDOVER



WATERFALL



BEVEL



CHAMFER





## NEWARK LEG

shown in Brown Maple  
with D22N08963  
Sandstone. Shown with  
Artisan Newark Chairs.

*(Note: Actual color  
may vary from picture)*







# NEWARK BENCH



- 1" Rectangle top with 2" radius corners and Mission edge standard
- 18" high
- Leaf storage box to store all 4 leaves
- Solid tops will not have center legs
- Fabric or Leather bench top available – solid top only. See page 32 for details.
- Shown in Brown Maple with D22N08963 Sandstone stain  
(Note: Actual color may vary from picture)



## SIZES

- 12 ½" X 48" Solid top or up to 4-12" leaves
- 12 ½" X 60" Solid top or up to 4-12" leaves
- 12 ½" X 72" Solid top or up to 4-12" leaves

## SPECIES

BROWN MAPLE • RED OAK • QSWO • CHERRY • HARD MAPLE • HICKORY • RUSTIC CHERRY • RUSTIC HICKORY • RUSTIC QSWO  
RUSTIC WALNUT • SAP CHERRY • WALNUT • WORMY MAPLE • PLAIN SAWN WHITE OAK • RUSTIC PLAIN SAWN WHITE OAK

## SHAPE OPTIONS



2" RADIUS  
CORNER

## EDGE OPTIONS



MISSION



# NEWBURY LEG



42" X 60" 30" high  
2-12" S/S leaves  
Brown Maple  
Standard shape & edge

- 1" Bow End top with Bevel edge standard
- 2 ½" straight skirt
- Legs standard as shown
- Floor to bottom of skirt 26½"
- Available in 36" height
- Recommended chair:  
Newbury from Artisan Chairs



## SIZES

42" X 60"	Up to 4-12" leaves or 1-18" butterfly leaf	Stores up to 4 leaves, 2 w/skirts & 2 w/o
42" X 66"	Up to 4-12" leaves or 1-18" butterfly leaf	Stores up to 4 leaves, 2 w/skirts & 2 w/o
42" X 72"	Up to 4-12" leaves or 1-18" butterfly leaf	Stores up to 4 leaves, 2 w/skirts & 2 w/o
48" X 60"	Up to 4-12" leaves or 1-18" butterfly leaf	Stores up to 4 leaves, 2 w/skirts & 2 w/o
48" X 66"	Up to 4-12" leaves or 1-18" butterfly leaf	Stores up to 4 leaves, 2 w/skirts & 2 w/o
48" X 72"	Up to 4-12" leaves or 1-18" butterfly leaf	Stores up to 4 leaves, 2 w/skirts & 2 w/o

Available 84" long, N/A with butterfly leaves. See pricelist for details.

For more than 4 leaves, see page 33

## SPECIES

BROWN MAPLE • RED OAK • QSWO • CHERRY • HARD MAPLE • HICKORY • RUSTIC CHERRY • RUSTIC HICKORY • RUSTIC QSWO  
RUSTIC WALNUT • SAP CHERRY • WALNUT • WORMY MAPLE • PLAIN SAWN WHITE OAK • RUSTIC PLAIN SAWN WHITE OAK

## SHAPE OPTIONS



Changing the top shape may affect self-store ability

## EDGE OPTIONS



## NEWBURY LEG

shown in Brown Maple  
with FC-924 Michaels  
Cherry top & FC-230  
Onyx base. Shown with  
Artisan Newbury Chairs.

*(Note: Actual color  
may vary from picture)*









# NEWBURY BENCH

- 1" Bow End top with Bevel edge standard
- 18" high
- Includes leaf storage box that stores all 4 leaves
- Solid tops will not have center legs
- Fabric or Leather bench top available – solid top only. See page 32 for details.



## **SIZES**

- |             |                                 |
|-------------|---------------------------------|
| 12 ½" X 48" | Solid top or up to 4-12" leaves |
| 12 ½" X 60" | Solid top or up to 4-12" leaves |
| 12 ½" X 72" | Solid top or up to 4-12" leaves |

## **SPECIES**

BROWN MAPLE • RED OAK • QSWO • CHERRY • HARD MAPLE • HICKORY • RUSTIC CHERRY • RUSTIC HICKORY • RUSTIC QSWO  
RUSTIC WALNUT • SAP CHERRY • WALNUT • WORMY MAPLE • PLAIN SAWN WHITE OAK • RUSTIC PLAIN SAWN WHITE OAK

## **SHAPE OPTIONS**



BOW END

## **EDGE OPTIONS**



BEVEL

# NORA SINGLE



- 1" Round top with Mission edge standard
- Base standard as shown with levelers
- Floor to bottom of skirt 26½"
- Available in 36" height
- Shown in Sap Cherry with FC-17882 Vintange Antique stain  
*(Note: Actual color may vary from picture)*



## SIZES

- |                 |  |
|-----------------|--|
| 42" X 42" Round | Up to 2-12" leaves                         |
| 48" X 48" Round | Up to 2-12" leaves or 1-18" butterfly leaf |
| 54" X 54" Round | Up to 2-12" leaves or 1-18" butterfly leaf |

## SPECIES

BROWN MAPLE • RED OAK • QSWO • CHERRY • HARD MAPLE • HICKORY • RUSTIC CHERRY • RUSTIC HICKORY • RUSTIC QSWO  
RUSTIC WALNUT • SAP CHERRY • WALNUT • WORMY MAPLE • PLAIN SAWN WHITE OAK • RUSTIC PLAIN SAWN WHITE OAK

## SHAPE OPTIONS



ROUND

## EDGE OPTIONS



MISSION  
(STANDARD)



5/8" ROUNDOVER



WATERFALL



BEVEL



CHAMFER



# OLDE CENTURY MISSION TRESTLE

- 1" Rectangle top with Mission edge standard
- Skirt standard with half-lap corner joints
- Trestle base is 24" wide
- Available in 36" height
- Floor to bottom of skirt 26½"
- Recommended chair: Olde Century from Artisan Chairs



## SIZES

42" X 60"	Up to 4-12" leaves or 1-18" butterfly leaf	Stores up to 4 unskirted leaves
42" X 66"	Up to 4-12" leaves or up to 2-18" butterfly leaves	Stores up to 4 leaves, 2 w/skirts & 2 w/o
42" X 72"	Up to 4-12" leaves or up to 2-18" butterfly leaves	Stores up to 4 leaves, 2 w/skirts & 2 w/o
48" X 60"	Up to 4-12" leaves or 1-18" butterfly leaf	Stores up to 4 leaves, 2 w/skirts & 2 w/o
48" X 66"	Up to 4-12" leaves or up to 2-18" butterfly leaves	Stores up to 4 unskirted leaves
48" X 72"	Up to 4-12" leaves or up to 2-18" butterfly leaves	Stores up to 4 unskirted leaves

Available 84" long, N/A with butterfly leaves. See pricelist for details.

For more than 4 leaves, see page 33

## SPECIES

BROWN MAPLE • RED OAK • QSWO • CHERRY • HARD MAPLE • HICKORY • RUSTIC CHERRY • RUSTIC HICKORY • RUSTIC QSWO  
RUSTIC WALNUT • SAP CHERRY • WALNUT • WORMY MAPLE • PLAIN SAWN WHITE OAK • RUSTIC PLAIN SAWN WHITE OAK

## SHAPE OPTIONS



RECTANGLE  
(STANDARD)



1" RADIUS  
CORNER



BOW END

## EDGE OPTIONS



MISSION  
(STANDARD)



5/8" ROUNDOVER



WATERFALL



BEVEL



CHAMFER



# OLDE CENTURY MISSION BENCH

- 1" Rectangle top with Mission edge standard
- Includes leaf storage box that stores all 4 leaves
- Solid tops will not have center legs
- Fabric or Leather bench top available – solid top only. See page 32 for details.



## **SIZES**

- 12 ½" X 48" Solid top or up to 4-12" leaves
- 12 ½" X 60" Solid top or up to 4-12" leaves
- 12 ½" X 72" Solid top or up to 4-12" leaves

## **SPECIES**

BROWN MAPLE • RED OAK • QSWO • CHERRY • HARD MAPLE • HICKORY • RUSTIC CHERRY • RUSTIC HICKORY • RUSTIC QSWO  
RUSTIC WALNUT • SAP CHERRY • WALNUT • WORMY MAPLE • PLAIN SAWN WHITE OAK • RUSTIC PLAIN SAWN WHITE OAK

## **SHAPE OPTIONS**



RECTANGLE

## **EDGE OPTIONS**



MISSION



## OREWOOD TRESTLE

Shown in Rough Sawn  
Wormy Maple with  
FC-42000 Almond 10  
sheen finish. Shown with  
Artisan Orowood Chairs.

*(Note: Actual color  
may vary from picture)*









# OREWOOD TRESTLE

- 1¼" Rectangle top with Mission edge standard
- Base standard as shown with levelers
- Floor to bottom of skirt 26½"
- Not available in pub height
- Shown in Rough Sawn Wormy Maple with FC-42000 Almond 10 sheen finish (Note: Actual color may vary from picture)



## SIZES

42" X 60"	Up to 4-12" leaves	Stores up to 4 unskirted leaves
42" X 66"	Up to 4-12" leaves	Stores up to 4 leaves, 2 w/skirts & 2 w/o
42" X 72"	Up to 4-12" leaves	Stores up to 4 leaves, 2 w/skirts & 2 w/o
48" X 60"	Up to 4-12" leaves	Stores up to 4 leaves, 2 w/skirts & 2 w/o
48" X 66"	Up to 4-12" leaves	Stores up to 4 unskirted leaves
48" X 72"	Up to 4-12" leaves	Stores up to 4 unskirted leaves

Available 84" long, N/A with butterfly leaves. See pricelist for details.

For more than 4 leaves, see page 33

## SPECIES

ROUGH SAWN WORMY MAPLE • ROUGH SAWN WHITE OAK

## SHAPE OPTIONS



RECTANGLE

## EDGE OPTIONS



MISSION

# PLYMOUTH LEG DROP LEAF



36" X 32"  
Solid top  
Oak  
Standard  
shape & edge

- 1" Rectangle top with Mission edge standard
- 2 - 10" drop leaves standard
- 3" x 3" Tapered legs standard as shown (optional legs: Lexington Mini, Straight or Traditional)
- Legs standard as shown with levelers
- Floor to bottom of skirt 26½"
- 20 7/8" between legs on sides
- Rectangle table shown in Red Oak with FC-42000 Almond stain; Oval table shown in Brown Maple with FC-50240 Carbon stain  
*(Note: Actual color may vary from picture)*



## SIZES

36" x 32" (36" x 52" with leaves up)  
42" x 32" (42" x 52" with leaves up)  
NO CUSTOM SIZES

Solid top or up to 4-12" center leaves  
Solid top or up to 4-12" center leaves

## SPECIES

BROWN MAPLE • RED OAK • QSWO • CHERRY • HARD MAPLE • HICKORY • RUSTIC CHERRY • RUSTIC HICKORY • RUSTIC QSWO  
RUSTIC WALNUT • SAP CHERRY • WALNUT • WORMY MAPLE • PLAIN SAWN WHITE OAK • RUSTIC PLAIN SAWN WHITE OAK

## SHAPE OPTIONS



RECTANGLE  
(STANDARD)



OVAL

## EDGE OPTIONS



MISSION  
(STANDARD)



5/8" ROUNDOVER



WATERFALL



BEVEL



CHAMFER



## PORTLAND SINGLE

shown in Shown  
in Sap Cherry with  
D22N08963 Sandstone  
stain. Shown with FN  
Savannah Chairs.

*(Note: Actual color  
may vary from picture)*







# PORTLAND SINGLE

- 1" Round top with Mission edge standard
- Base standard as shown with levelers
- Floor to bottom of skirt 26½"
- Not available in pub height
- Shown in Rustic Cherry with FC-44688 Medium Walnut finish  
*(Note: Actual color may vary from picture)*



## SIZES

48" X 48" Round	Up to 2-12" leaves or 1-18" butterfly leaf
54" X 54" Round	Up to 2-12" leaves or 1-18" butterfly leaf
60" X 60" Round	Up to 2-12" leaves

## SPECIES

BROWN MAPLE • RED OAK • QSWO • CHERRY • HARD MAPLE • HICKORY • RUSTIC CHERRY • RUSTIC HICKORY • RUSTIC QSWO  
RUSTIC WALNUT • SAP CHERRY • WALNUT • WORMY MAPLE • PLAIN SAWN WHITE OAK • RUSTIC PLAIN SAWN WHITE OAK

## SHAPE OPTIONS



ROUND

## EDGE OPTIONS



MISSION  
(STANDARD)



5/8" ROUND OVER



WATERFALL



BEVEL



CHAMFER



# PRESTON DOUBLE

- 1" Oval top with Roundover edge standard
- Base standard as shown with levelers
- Floor to bottom of skirt 26½"
- Available in 36" height



## SIZES

42" X 60"	Up to 4-12" leaves	2 leaf stores 1 w/skirts & 1 w/o	4 leaf cannot self-store
42" X 66"	Up to 4-12" leaves	2 leaf stores both with skirts	4 leaf stores 2 leaves, 1 w/skirts & 1 w/o
42" X 72"	Up to 4-12" leaves	2 leaf stores both with skirts	4 leaf stores 2 leaves, 1 w/skirts & 1 w/o
48" X 60"	Up to 4-12" leaves	2 leaf stores 1 w/skirts & 1 w/o	4 leaf cannot self-store
48" X 66"	Up to 4-12" leaves	2 leaf stores both with skirts	4 leaf stores 2 leaves, 1 w/skirts & 1 w/o
48" X 72"	Up to 4-12" leaves	2 leaf stores both with skirts	4 leaf stores 4 leaves, 2 w/skirts & 2 w/o

For more than 4 leaves, see page 33

## SPECIES

BROWN MAPLE • RED OAK • QSWO • CHERRY • HARD MAPLE • HICKORY • RUSTIC CHERRY • RUSTIC HICKORY • RUSTIC QSWO  
RUSTIC WALNUT • SAP CHERRY • WALNUT • WORMY MAPLE • PLAIN SAWN WHITE OAK • RUSTIC PLAIN SAWN WHITE OAK

## SHAPE OPTIONS



RECTANGLE



1" RADIUS  
CORNER



BOW END



OVAL  
(STANDARD)



BOAT



BANQUET

Changing the top shape may affect self-store ability

## EDGE OPTIONS



MISSION



5/8" ROUNDOVER  
(STANDARD)



WATERFALL



BEVEL



CHAMFER





# PRESTON SINGLE

- 1" Round top with Roundover edge standard
- Base standard as shown with levelers
- Floor to bottom of skirt 26½"
- Available in 36" height



## SIZES

- 42" X 42" Round    Up to 2-12" leaves  
48" X 48" Round    Up to 2-12" leaves or 1-18" butterfly leaf

## SPECIES

BROWN MAPLE • RED OAK • QSWO • CHERRY • HARD MAPLE • HICKORY • RUSTIC CHERRY • RUSTIC HICKORY • RUSTIC QSWO  
RUSTIC WALNUT • SAP CHERRY • WALNUT • WORMY MAPLE • PLAIN SAWN WHITE OAK • RUSTIC PLAIN SAWN WHITE OAK

## SHAPE OPTIONS



ROUND

## EDGE OPTIONS



MISSION



5/8" ROUNDOVER  
(STANDARD)



WATERFALL



BEVEL



CHAMFER

# RENO TRESTLE

- 1" Bow End top with Waterfall edge standard
- Base standard as shown with levelers
- Available in 36" height
- Floor to bottom of skirt 26½"
- Recommended chair: Reno from Artisan Chairs



## SIZES

42" X 60"	Up to 4-12" leaves or 1-18" butterfly leaf	Stores up to 4 unskirted leaves
42" X 66"	Up to 4-12" leaves or up to 2-18" butterfly leaves	Stores up to 4 leaves, 2 w/skirts & 2 w/o
42" X 72"	Up to 4-12" leaves or up to 2-18" butterfly leaves	Stores up to 4 leaves, 2 w/skirts & 2 w/o
48" X 60"	Up to 4-12" leaves or 1-18" butterfly leaf	Stores up to 4 leaves, 2 w/skirts & 2 w/o
48" X 66"	Up to 4-12" leaves or up to 2-18" butterfly leaves	Stores up to 4 unskirted leaves
48" X 72"	Up to 4-12" leaves or up to 2-18" butterfly leaves	Stores up to 4 unskirted leaves

Available 84" long, N/A with butterfly leaves. See pricelist for details.

For more than 4 leaves, see page 33

## SPECIES

BROWN MAPLE • RED OAK • QSWO • CHERRY • HARD MAPLE • HICKORY • RUSTIC CHERRY • RUSTIC HICKORY • RUSTIC QSWO  
RUSTIC WALNUT • SAP CHERRY • WALNUT • WORMY MAPLE • PLAIN SAWN WHITE OAK • RUSTIC PLAIN SAWN WHITE OAK

## SHAPE OPTIONS



Changing the top shape may affect self-store ability

## EDGE OPTIONS



## RENO TRESTLE

shown in Cherry with  
Michael's Cherry stain.  
Shown with Reno Chairs  
from Artisan Chairs.

*(Note: Actual color  
may vary from picture)*







# RENO BENCH

- 1" Rectangle top with Mission edge standard
- 18" high
- Leaf storage box to store up to 4 leaves
- Solid tops will not have center legs
- Fabric or Leather bench top available – solid top only. See page 32 for details.



## SIZES

- |             |                                 |
|-------------|---------------------------------|
| 12 ½" X 48" | Solid top or up to 4-12" leaves |
| 12 ½" X 60" | Solid top or up to 4-12" leaves |
| 12 ½" X 72" | Solid top or up to 4-12" leaves |

## SPECIES

BROWN MAPLE • RED OAK • QSWO • CHERRY • HARD MAPLE • HICKORY • RUSTIC CHERRY • RUSTIC HICKORY • RUSTIC QSWO  
RUSTIC WALNUT • SAP CHERRY • WALNUT • WORMY MAPLE • PLAIN SAWN WHITE OAK • RUSTIC PLAIN SAWN WHITE OAK

## SHAPE OPTIONS



RECTANGLE

## EDGE OPTIONS



MISSION



# RIDGECREST DOUBLE

- 1" Rectangle top with Mission edge standard
- Base standard as shown with levelers
- Floor to bottom of skirt 26½"
- Not available in pub height



## SIZES

42" X 66"	Up to 4-12" leaves	Stores up to 4 leaves, 2 w/skirts & 2 w/o
42" X 72"	Up to 4-12" leaves	Stores up to 4 leaves, 2 w/skirts & 2 w/o
48" X 66"	Up to 4-12" leaves	Stores up to 4 leaves, 2 w/skirts & 2 w/o
48" X 72"	Up to 4-12" leaves	Stores up to 4 leaves, 2 w/skirts & 2 w/o

NOT AVAILABLE IN 60" LENGTH

*For more than 4 leaves, see page 33*

## SPECIES

BROWN MAPLE • RED OAK • QSWO • CHERRY • HARD MAPLE • HICKORY • RUSTIC CHERRY • RUSTIC HICKORY • RUSTIC QSWO  
RUSTIC WALNUT • SAP CHERRY • WALNUT • WORMY MAPLE • PLAIN SAWN WHITE OAK • RUSTIC PLAIN SAWN WHITE OAK

## SHAPE OPTIONS



*Changing the top shape may affect self-store ability*

## EDGE OPTIONS





# RIDGEWOOD SINGLE

- 1" Round top with Mission edge standard
- Base standard as shown with levelers
- Floor to bottom of skirt 26½"
- Available in 36" height (NOT available on 54" round)



## SIZES

42" X 42" Round	Up to 2-12" leaves
48" X 48" Round	Up to 2-12" leaves or 1-18" butterfly leaf
54" X 54" Round	Up to 2-12" leaves or 1-18" butterfly leaf

## SPECIES

BROWN MAPLE • RED OAK • QSWO • CHERRY • HARD MAPLE • HICKORY • RUSTIC CHERRY • RUSTIC HICKORY • RUSTIC QSWO  
RUSTIC WALNUT • SAP CHERRY • WALNUT • WORMY MAPLE • PLAIN SAWN WHITE OAK • RUSTIC PLAIN SAWN WHITE OAK

## SHAPE OPTIONS



ROUND

## EDGE OPTIONS



MISSION  
(STANDARD)



5/8" ROUNDOVER



WATERFALL



BEVEL



CHAMFER

# SANTA FE LEG

- 1¾" Rectangle top with Mission edge standard
- Recommended chair: Houston from FN Chairs
- Floor to bottom of skirt 25½"
- Available in 36" height
- Shown in Rough Sawn Wormy Maple with FC-42000 Almond 10 sheen finish  
*(Note: Actual color may vary from picture)*



## SIZES

42" X 60"	Up to 3-16" leaves	Self-store not available
42" X 66"	Up to 3-16" leaves	Self-store not available
42" X 72"	Up to 3-16" leaves	Self-store not available
48" X 60"	Up to 3-16" leaves	Self-store not available
48" X 66"	Up to 3-16" leaves	Self-store not available
48" X 72"	Up to 3-16" leaves	Self-store not available

Available 84" long, N/A with butterfly leaves. See pricelist for details.

## SPECIES

ROUGH SAWN WORMY MAPLE

## SHAPE OPTIONS



RECTANGLE

## EDGE OPTIONS



MISSION





## SANTA FE LEG

shown in Rough Sawn  
Wormy Maple with  
FC-42000 Almond  
10 sheen finish. Shown  
with FN Chairs  
Houston chairs.

*(Note: Actual color  
may vary from picture)*









# SANTA FE BENCH

---

- 1¾" Rectangle top with Mission edge standard
- Solid tops will not have center legs
- Fabric or Leather bench top available – solid top only. See page 32 for details.
- Shown in Rough Sawn Wormy Maple with FC-42000 Almond 10 sheen finish  
(Note: Actual color may vary from picture)



## **SIZES**

---

12 ½" X 48"	Solid top or up to 3-16" leaves
12 ½" X 60"	Solid top or up to 3-16" leaves
12 ½" X 72"	Solid top or up to 3-16" leaves

## **SPECIES**

---

ROUGH SAWN WORMY MAPLE

## **SHAPE OPTIONS**

---



RECTANGLE

## **EDGE OPTIONS**

---



MISSION

# SARATOGA TRESTLE

- 1 ¼" Semi-Boat shape top standard
- Edge standard as shown
- Base standard as shown with levelers
- Not available in pub height
- Floor to bottom of skirt 26½"



## SIZES

42" X 72" Up to 4-12" leaves Stores up to 4 leaves, 2 w/skirts & 2 w/o  
48" X 72" Up to 4-12" leaves Stores up to 4 unskirted leaves

Available 84" long, N/A with butterfly leaves. See pricelist for details.

For more than 4 leaves, see page 33

## SPECIES

BROWN MAPLE • RED OAK • QSWO • CHERRY • HARD MAPLE • HICKORY • RUSTIC CHERRY • RUSTIC HICKORY • RUSTIC QSWO  
RUSTIC WALNUT • SAP CHERRY • WALNUT • WORMY MAPLE • PLAIN SAWN WHITE OAK • RUSTIC PLAIN SAWN WHITE OAK

## SHAPE OPTIONS



SEMI-BOAT

## EDGE OPTIONS





## SARATOGA TRESTLE

shown in Brown Maple  
with Autumn Leaf top &  
Onyx base. Shown with  
FN Chairs Brookfield  
chairs in Brown Maple  
finished with an Onyx  
stain and Linen fabric.

*(Note: Actual color  
may vary from picture)*









# SHELBY TRESTLE

- 1" Bow End top with Waterfall edge standard
- Base standard as shown with levelers
- Floor to bottom of skirt 26½"
- Not available in pub height
- Shown in Sap Cherry with FC-48024 American Antique finish  
(Note: Actual color may vary from picture)



## SIZES

36" X 48"	Up to 3-12" leaves	Stores up to 2 unskirted leaves
36" X 54"	Up to 3-12" leaves	Stores up to 2 unskirted leaves
36" X 60"	Up to 3-12" leaves	Stores up to 2 unskirted leaves
42" X 48"	Up to 3-12" leaves	Self-store NOT available
42" X 54"	Up to 3-12" leaves	Stores up to 3 unskirted leaves
42" X 60"	Up to 3-12" leaves	Stores up to 3 unskirted leaves

## SPECIES

BROWN MAPLE • RED OAK • QSWO • CHERRY • HARD MAPLE • HICKORY • RUSTIC CHERRY • RUSTIC HICKORY • RUSTIC QSWO  
RUSTIC WALNUT • SAP CHERRY • WALNUT • WORMY MAPLE • PLAIN SAWN WHITE OAK • RUSTIC PLAIN SAWN WHITE OAK

## SHAPE OPTIONS



RECTANGLE



1" RADIUS  
CORNER



BOW END  
(STANDARD)

## EDGE OPTIONS



MISSION



5/8" ROUND OVER



WATERFALL  
(STANDARD)



BEVEL



CHAMFER



# SHERIDAN TRESTLE



36" X 54" 30" high  
2-12" S/S leaves  
Red Oak  
Standard shape & edge

- 1" Bow End top with Chamfer edge standard
- Base standard as shown with levelers
- Floor to bottom of skirt 26½"
- Available in 36" height



## SIZES

36" X 48"	Up to 3-12" leaves	Stores up to 2 unskirted leaves
36" X 54"	Up to 3-12" leaves	Stores up to 2 unskirted leaves
36" X 60"	Up to 3-12" leaves	Stores up to 2 unskirted leaves
42" X 48"	Up to 3-12" leaves	Self-store NOT available
42" X 54"	Up to 3-12" leaves	Stores up to 3 unskirted leaves
42" X 60"	Up to 3-12" leaves	Stores up to 3 unskirted leaves

## SPECIES

BROWN MAPLE • RED OAK • QSWO • CHERRY • HARD MAPLE • HICKORY • RUSTIC CHERRY • RUSTIC HICKORY • RUSTIC QSWO  
RUSTIC WALNUT • SAP CHERRY • WALNUT • WORMY MAPLE • PLAIN SAWN WHITE OAK • RUSTIC PLAIN SAWN WHITE OAK

## SHAPE OPTIONS



RECTANGLE



1" RADIUS  
CORNER



BOW END  
(STANDARD)

## EDGE OPTIONS



MISSION



5/8" ROUNDOVER



WATERFALL



BEVEL



CHAMFER  
(STANDARD)



## SHERIDAN TRESTLE

shown in Red Oak with  
D22N08963 Sandstone  
stain. Shown with FN  
Abe Chairs.

*(Note: Actual color  
may vary from picture)*









# SHERIDAN BENCH

- 1" Rectangle top with Mission edge standard
- 18" high
- Leaf storage box to store all 3 leaves
- Solid tops will not have center legs
- Fabric or Leather bench top available – solid top only. See page 32 for details.
- Shown in Red Oak with Asbury Brown stain  
(Note: Actual color may vary from picture)



## **SIZES**

12 ½" X 48"	Solid top or up to 3-12" leaves
12 ½" X 54"	Solid top or up to 3-12" leaves
12 ½" X 60"	Solid top or up to 3-12" leaves

## **SPECIES**

BROWN MAPLE • RED OAK • QSWO • CHERRY • HARD MAPLE • HICKORY • RUSTIC CHERRY • RUSTIC HICKORY • RUSTIC QSWO  
RUSTIC WALNUT • SAP CHERRY • WALNUT • WORMY MAPLE • PLAIN SAWN WHITE OAK • RUSTIC PLAIN SAWN WHITE OAK

## **SHAPE OPTIONS**



RECTANGLE

## **EDGE OPTIONS**



MISSION

# SIERRA TRESTLE

- 1" Rectangle top with Mission edge standard
- Base standard as shown with levelers
- Available in 36" height
- Floor to bottom of skirt 26½"
- Recommended chair: Sierra from Artisan Chairs



## SIZES

42" X 60"	Up to 4-12" leaves or 1-18" butterfly leaf	Stores up to 4 unskirted leaves
42" X 66"	Up to 4-12" leaves or up to 2-18" butterfly leaves	Stores up to 4 leaves, 2 w/skirts & 2 w/o
42" X 72"	Up to 4-12" leaves or up to 2-18" butterfly leaves	Stores up to 4 leaves, 2 w/skirts & 2 w/o
48" X 60"	Up to 4-12" leaves or 1-18" butterfly leaf	Stores up to 4 leaves, 2 w/skirts & 2 w/o
48" X 66"	Up to 4-12" leaves or up to 2-18" butterfly leaves	Stores up to 4 unskirted leaves
48" X 72"	Up to 4-12" leaves or up to 2-18" butterfly leaves	Stores up to 4 unskirted leaves

Available 84" long, N/A with butterfly leaves. See pricelist for details.

For more than 4 leaves, see page 33

## SPECIES

BROWN MAPLE • RED OAK • QSWO • CHERRY • HARD MAPLE • HICKORY • RUSTIC CHERRY • RUSTIC HICKORY • RUSTIC QSWO  
 RUSTIC WALNUT • SAP CHERRY • WALNUT • WORMY MAPLE • PLAIN SAWN WHITE OAK • RUSTIC PLAIN SAWN WHITE OAK

## SHAPE OPTIONS



Changing the top shape may affect self-store ability

## EDGE OPTIONS



## SONOMA SINGLE

shown in Brown Maple  
with FC-24427 Shadow  
top & SP-170 Weathered  
Snow White 10 sheen  
base. Shown with FN  
Raleigh Chairs.

*(Note: Actual color  
may vary from picture)*







# SONOMA SINGLE

- 1¼" Round top with Waterfall edge standard
- Base standard as shown with levelers
- Floor to bottom of skirt 26½"
- Available in 36" height
- Shown in Brown Maple with FC-24427 Shadow top & SP-170 Weathered Snow White 10 sheen base  
*(Note: Actual color may vary from picture)*



## SIZES

48" X 48" Round	Up to 2-12" leaves
54" X 54" Round	Up to 2-12" leaves
60" X 60" Round	Up to 2-12" leaves
72" X 72" Round	Solid top only

## SPECIES

BROWN MAPLE • RED OAK • QSWO • CHERRY • HARD MAPLE • HICKORY • RUSTIC CHERRY • RUSTIC HICKORY • RUSTIC QSWO  
RUSTIC WALNUT • SAP CHERRY • WALNUT • WORMY MAPLE • PLAIN SAWN WHITE OAK • RUSTIC PLAIN SAWN WHITE OAK

## SHAPE OPTIONS



ROUND

## EDGE OPTIONS



MISSION



5/8" ROUNDOVER



WATERFALL  
(STANDARD)



BEVEL



CHAMFER

# STANWOOD LEG

- 1¼" Rectangle top with Mission edge standard
- 4" x 4" leg standard as shown
- Not available in pub height
- 3½" straight skirt
- Floor to bottom of skirt 25½"



## SIZES

42" X 60"	Up to 4-12" leaves	Stores up to 4 leaves, 2 w/skirts & 2 w/o
42" X 66"	Up to 4-12" leaves	Stores up to 4 leaves, 2 w/skirts & 2 w/o
42" X 72"	Up to 4-12" leaves	Stores up to 4 leaves, 2 w/skirts & 2 w/o
48" X 60"	Up to 4-12" leaves	Stores up to 4 leaves, 2 w/skirts & 2 w/o
48" X 66"	Up to 4-12" leaves	Stores up to 4 leaves, 2 w/skirts & 2 w/o
48" X 72"	Up to 4-12" leaves	Stores up to 4 leaves, 2 w/skirts & 2 w/o

Available 84" long, N/A with butterfly leaves. See pricelist for details.

For more than 4 leaves, see page 33

## SPECIES

BROWN MAPLE • RED OAK • QSWO • CHERRY • HARD MAPLE • HICKORY • RUSTIC CHERRY • RUSTIC HICKORY • RUSTIC QSWO  
RUSTIC WALNUT • SAP CHERRY • WALNUT • WORMY MAPLE • PLAIN SAWN WHITE OAK • RUSTIC PLAIN SAWN WHITE OAK

## SHAPE OPTIONS



RECTANGLE  
(STANDARD)



1" RADIUS  
CORNER



BOW END

## EDGE OPTIONS



MISSION  
(STANDARD)



5/8" ROUNDOVER



WATERFALL



BEVEL



CHAMFER





# SYDNEY TRESTLE



- 1¼" Semi-Boat top with Underbevel edge standard
- Grain lengthwise is standard
- Base standard as shown with levelers
- Not available in pub height
- Shown in Brown Maple with D22N11322 Granola 3 sheen finish  
(Note: Actual color may vary from picture)



## SIZES

42" X 72"	Solid top only
42" X 84"	Solid top only
42" X 96"	Solid top only
48" X 72"	Solid top only
48" X 84"	Solid top only
48" X 96"	Solid top only

## SPECIES

BROWN MAPLE • RED OAK • QSWO • CHERRY • HARD MAPLE • HICKORY • RUSTIC CHERRY • RUSTIC HICKORY • RUSTIC QSWO  
RUSTIC WALNUT • SAP CHERRY • WALNUT • WORMY MAPLE • PLAIN SAWN WHITE OAK • RUSTIC PLAIN SAWN WHITE OAK

## SHAPE OPTIONS



SEMI-BOAT

## EDGE OPTIONS



UNDERBEVEL

# TRADITIONAL DOUBLE

- Oval top with Roundover edge standard
- Classic Empire feet standard as shown with levelers, also available with claw feet
- Bar spreader standard as shown, Spindle Rail is also available
- Available in 36" height
- Floor to bottom of skirt 26½"



## SIZES

42" X 60"	Up to 4-12" leaves	2 leaf stores 1 w/skirts & 1 w/o	4 leaf cannot self-store
42" X 66"	Up to 4-12" leaves	2 leaf stores both with skirts	4 leaf stores 2 leaves, 1 w/skirts & 1 w/o
42" X 72"	Up to 4-12" leaves	2 leaf stores both with skirts	4 leaf stores 2 leaves, 1 w/skirts & 1 w/o
48" X 60"	Up to 4-12" leaves	2 leaf stores 1 w/skirts & 1 w/o	4 leaf cannot self-store
48" X 66"	Up to 4-12" leaves	2 leaf stores both with skirts	4 leaf stores 2 leaves, 1 w/skirts & 1 w/o
48" X 72"	Up to 4-12" leaves	2 leaf stores both with skirts	4 leaf stores 4 leaves, 2 w/skirts & 2 w/o

For more than 4 leaves, see page 33

## SPECIES

BROWN MAPLE • RED OAK • QSWO • CHERRY • HARD MAPLE • HICKORY • RUSTIC CHERRY • RUSTIC HICKORY • RUSTIC QSWO  
RUSTIC WALNUT • SAP CHERRY • WALNUT • WORMY MAPLE • PLAIN SAWN WHITE OAK • RUSTIC PLAIN SAWN WHITE OAK

## SHAPE OPTIONS



Changing the top shape may affect self-store ability

## EDGE OPTIONS



# TRADITIONAL DOUBLE SCALLOP

- 1" Scallop Oval top with Bevel edge standard
- Classic empire feet standard as shown with levelers, also available with claw feet
- Spindle rail also available
- Available in 36" height
- Floor to bottom of skirt 26½"



## SIZES

42" X 60"	Up to 4-12" leaves	2 leaf stores 1 w/skirts & 1 w/o	4 leaf cannot self-store
42" X 66"	Up to 4-12" leaves	2 leaf stores both with skirts	4 leaf stores 2 leaves, 1 w/skirts & 1 w/o
42" X 72"	Up to 4-12" leaves	2 leaf stores both with skirts	4 leaf stores 2 leaves, 1 w/skirts & 1 w/o
48" X 60"	Up to 4-12" leaves	2 leaf stores 1 w/skirts & 1 w/o	4 leaf cannot self-store
48" X 66"	Up to 4-12" leaves	2 leaf stores both with skirts	4 leaf stores 2 leaves, 1 w/skirts & 1 w/o
48" X 72"	Up to 4-12" leaves	2 leaf stores both with skirts	4 leaf stores 4 leaves, 2 w/skirts & 2 w/o

For more than 4 leaves, see page 33

## SPECIES

BROWN MAPLE • RED OAK • QSWO • CHERRY • HARD MAPLE • HICKORY • RUSTIC CHERRY • RUSTIC HICKORY • RUSTIC QSWO  
RUSTIC WALNUT • SAP CHERRY • WALNUT • WORMY MAPLE • PLAIN SAWN WHITE OAK • RUSTIC PLAIN SAWN WHITE OAK

## SHAPE OPTIONS



Changing the top shape may affect self-store ability

## EDGE OPTIONS





# TRADITIONAL LEG

- Rectangle top with 4" corner radius and Roundover edge standard
- Table skirt standard as shown
- Available in 36" height
- Non-geared wooden slides
- Floor to bottom of skirt 24½" at the legs and 26½" at the center



## SIZES

42" X 60"	Up to 4-12" leaves or 1-18" butterfly leaf	Stores up to 4 leaves, 2 w/skirts & 2 w/o
42" X 66"	Up to 4-12" leaves or 1-18" butterfly leaf	Stores up to 4 leaves, 2 w/skirts & 2 w/o
42" X 72"	Up to 4-12" leaves or 1-18" butterfly leaf	Stores up to 4 leaves, 2 w/skirts & 2 w/o
48" X 60"	Up to 4-12" leaves or 1-18" butterfly leaf	Stores up to 4 leaves, 2 w/skirts & 2 w/o
48" X 66"	Up to 4-12" leaves or 1-18" butterfly leaf	Stores up to 4 leaves, 2 w/skirts & 2 w/o
48" X 72"	Up to 4-12" leaves or 1-18" butterfly leaf	Stores up to 4 leaves, 2 w/skirts & 2 w/o

Available 84" long, N/A with butterfly leaves. See pricelist for details.

For more than 4 leaves, see page 33

## SPECIES

BROWN MAPLE • RED OAK • QSWO • CHERRY • HARD MAPLE • HICKORY • RUSTIC CHERRY • RUSTIC HICKORY • RUSTIC QSWO  
RUSTIC WALNUT • SAP CHERRY • WALNUT • WORMY MAPLE • PLAIN SAWN WHITE OAK • RUSTIC PLAIN SAWN WHITE OAK

## SHAPE OPTIONS



RECTANGLE



4" RADIUS  
CORNER (STD)



BOW END

## EDGE OPTIONS



MISSION



5/8" ROUNDOVER  
(STANDARD)



WATERFALL



BEVEL



CHAMFER



# TRADITIONAL SINGLE PUB

- 1" Round solid top with Roundover edge standard
- Classic empire feet standard as shown with levelers, also available with claw feet
- 36" high standard. Also available in 30" & 42" h
- Floor to bottom of skirt 32½"



## SIZES

36" X 36" Round	Solid top only
42" X 42" Round	Solid top only
48" X 48" Round	Solid top only

## SPECIES

BROWN MAPLE • RED OAK • QSWO • CHERRY • HARD MAPLE • HICKORY • RUSTIC CHERRY • RUSTIC HICKORY • RUSTIC QSWO  
RUSTIC WALNUT • SAP CHERRY • WALNUT • WORMY MAPLE • PLAIN SAWN WHITE OAK • RUSTIC PLAIN SAWN WHITE OAK

## SHAPE OPTIONS



ROUND

## EDGE OPTIONS



MISSION



5/8" ROUNDOVER  
(STANDARD)



WATERFALL



BEVEL



CHAMFER

# TRADITIONAL SINGLE

- Round top with Roundover edge standard
- Classic empire feet standard as shown with levelers, also available with claw feet
- Floor to bottom of skirt 26½"
- Available in 36" height



## SIZES

- 36" X 36" Round Up to 2-12" leaves
- 42" X 42" Round Up to 2-12" leaves
- 48" X 48" Round Up to 2-12" leaves or 1-18" butterfly leaf

## SPECIES

BROWN MAPLE • RED OAK • QSWO • CHERRY • HARD MAPLE • HICKORY • RUSTIC CHERRY • RUSTIC HICKORY • RUSTIC QSWO  
RUSTIC WALNUT • SAP CHERRY • WALNUT • WORMY MAPLE • PLAIN SAWN WHITE OAK • RUSTIC PLAIN SAWN WHITE OAK

## SHAPE OPTIONS



ROUND

## EDGE OPTIONS



MISSION



5/8" ROUNDROVER  
(STANDARD)



WATERFALL



BEVEL



CHAMFER





## TULSA CABINET

shown in Rough Sawn  
Wormy Maple with  
SP-166 Weathered  
Treebark 10 sheen top  
and SP-167 Weathered  
Tusk 10 sheen base.  
Shown with FN Chairs  
Houston Bar Stools.

*(Note: Actual color  
may vary from picture)*









# TULSA CABINET

- 1¾" Rectangle top with Mission edge standard
- Cabinet base is 36" w x 25" d (no options on cabinet size)
- Standard with 3 drawers and sliding door with adjustable shelves (no options)
- Undermount soft-close drawer slides
- 36" high standard also available 42" high
- Floor to bottom of skirt 32½"
- Shown in Rough Sawn Wormy Maple with SP-166 Weathered Treebark 10 sheen top and SP-167 Weathered Tusk 10 sheen base  
*(Note: Actual color may vary from picture)*



## SIZES

- 42" X 60" Up to 2-16" leaves
- 42" X 72" Up to 2-16" leaves
- 48" X 60" Up to 2-16" leaves
- 48" X 72" Up to 2-16" leaves

## SPECIES

ROUGH SAWN WORMY MAPLE

## SHAPE OPTIONS



RECTANGLE

## EDGE OPTIONS



MISSION



# VANCOUVER TRESTLE

- 1" Bow End top with Mission edge standard
- Base standard as shown with levelers
- Floor to bottom of skirt 26½"
- Available in 36" height



## SIZES

42" X 60"	Up to 4-12" leaves or 1-18" butterfly leaf	Stores up to 4 unskirted leaves
42" X 66"	Up to 4-12" leaves or up to 2-18" butterfly leaves	Stores up to 4 leaves, 2 w/skirts & 2 w/o
42" X 72"	Up to 4-12" leaves or up to 2-18" butterfly leaves	Stores up to 4 leaves, 2 w/skirts & 2 w/o
48" X 60"	Up to 4-12" leaves or 1-18" butterfly leaf	Stores up to 4 leaves, 2 w/skirts & 2 w/o
48" X 66"	Up to 4-12" leaves or up to 2-18" butterfly leaves	Stores up to 4 unskirted leaves
48" X 72"	Up to 4-12" leaves or up to 2-18" butterfly leaves	Stores up to 4 unskirted leaves

Available 84" long, N/A with butterfly leaves. See pricelist for details.

For more than 4 leaves, see page 33

## SPECIES

BROWN MAPLE • RED OAK • QSWO • CHERRY • HARD MAPLE • HICKORY • RUSTIC CHERRY • RUSTIC HICKORY • RUSTIC QSWO  
 RUSTIC WALNUT • SAP CHERRY • WALNUT • WORMY MAPLE • PLAIN SAWN WHITE OAK • RUSTIC PLAIN SAWN WHITE OAK

## SHAPE OPTIONS



Changing the top shape may affect self-store ability

## EDGE OPTIONS



## WABASH BARREL

shown in Rustic Hickory  
with FC-44688 Medium  
Walnut stain. Shown  
with Artisan Wabash  
Chairs.

*(Note: Actual color  
may vary from picture)*









# WABASH BARREL SINGLE

- 1¼" Round top with Mission edge standard
- Base standard as shown with levelers
- 36" high standard
- Black powder coated metal base
- Floor to bottom of skirt 32½"
- Shown in Rustic Hickory with FC-44688 Medium Walnut finish  
*(Note: Actual color may vary from picture)*



## SIZES

- 48" X 48" Round    Up to 2-12" leaves
- 54" X 54" Round    Up to 2-12" leaves

## SPECIES

BROWN MAPLE • RED OAK • QSWO • CHERRY • HARD MAPLE • HICKORY • RUSTIC CHERRY • RUSTIC HICKORY • RUSTIC QSWO  
RUSTIC WALNUT • SAP CHERRY • WALNUT • WORMY MAPLE • PLAIN SAWN WHITE OAK • RUSTIC PLAIN SAWN WHITE OAK

## SHAPE OPTIONS



ROUND

## EDGE OPTIONS



MISSION  
(STANDARD)



5/8" ROUND OVER



WATERFALL



BEVEL



CHAMFER

# WELLINGTON TRESTLE

- 3" edge band top with random grooves and breadboard ends (no grooves in leaves)
- 1/4" Roundover edge and corners
- Ball bearing slides are standard
- Base standard as shown with levelers
- Available in 36" height



## SIZES

42" X 88" Solid top or 2-16" leaves  
48" X 88" Solid top or 2-16" leaves

Self-store not available  
Self-store not available

## SPECIES

BROWN MAPLE • RED OAK • QSWO • CHERRY • RUSTIC CHERRY • RUSTIC QSWO • RUSTIC WALNUT  
SAP CHERRY • WALNUT • WORMY MAPLE • PLAIN SAWN WHITE OAK • RUSTIC PLAIN SAWN WHITE OAK  
*N/A IN GREY ELM, HARD MAPLE, HICKORY, RUSTIC HICKORY*

## SHAPE OPTIONS



1/4" RADIUS  
CORNER

## EDGE OPTIONS



1/4" ROUNDOVER



## WELLINGTON TRESTLE

shown in Brown Maple  
with a 3" edge band top  
in SP-156 Worn Spice  
Med. Distressed  
10 sheen stain. Shown  
with FN Chairs  
Ramsey chairs.

*(Note: Actual color  
may vary from picture)*









# WESTIN SINGLE

- 1¼" Round top with Mission edge standard
- Base standard as shown with levelers
- Not available in pub height
- Quarter Sawn White Oak tables will have regular White Oak base
- Floor to bottom of skirt 26½"



## SIZES

48" X 48" Round	Up to 2-12" leaves
54" X 54" Round	Up to 2-12" leaves
60" X 60" Round	Up to 2-12" leaves
72" X 72" Round	Solid top only

## SPECIES

BROWN MAPLE • RED OAK • QSWO • CHERRY • RUSTIC CHERRY • RUSTIC QSWO • RUSTIC WALNUT  
SAP CHERRY • WALNUT • WORMY MAPLE • PLAIN SAWN WHITE OAK • RUSTIC PLAIN SAWN WHITE OAK  
N/A IN GREY ELM, HARD MAPLE, HICKORY, RUSTIC HICKORY

## SHAPE OPTIONS



ROUND

## EDGE OPTIONS



MISSION  
(STANDARD)



5/8" ROUNDOVER



WATERFALL



BEVEL



CHAMFER

# Home of West Point Woodworking, LLC

